



Wireless Microphone Technology Guide





www.line6.com

© 2010 Line 6, Inc.
Version 1.3

All rights reserved
Reproduction in whole or part
without written permission is prohibited

Electronic version available at <http://line6.com/xd-v>.

What's Inside

Introduction	4
The Basics	5
What is RF?	5
RF Transmission	5
RF Reception	5
Radio Operation	5
Choosing a Frequency	5
Radio Interference	7
Radio Distance	8
Diversity	8
Choosing a Channel	9
Audio Transmission	9
Dynamic Range	9
Distortion	11
Frequency Response	11
Summary	11
Digital Benefits	11

Introduction

Wireless microphones provide singers, performers, and presenters with the freedom of mobility unconstrained by cables. But this benefit has historically been provided at the cost of compromised audio quality, radio interference artifacts, and setup complexity. For over fifty years analog FM radio technology has been the dominant approach utilized for wireless microphones, but now digital wireless promises to usher in an era of uncompromised, problem-free performance.

This paper’s goal is to provide a technical background of both traditional analog wireless and digital wireless technology, and to provide insight into the differences between them.

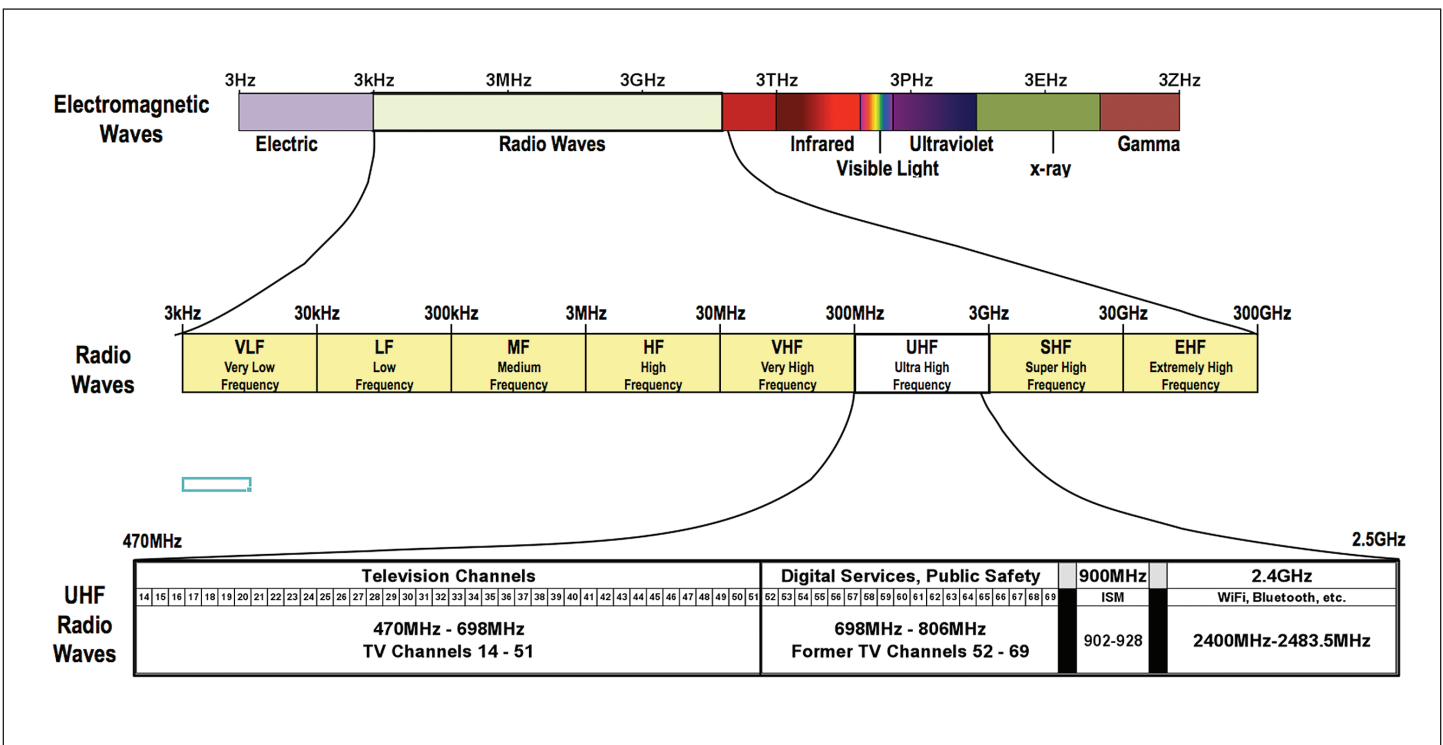

Figure 1 Radio waves range from 3 kHz to 300GHz in the Electromagnetic Spectrum. Professional wireless microphones operate in the UHF range of radio waves.

The Basics

What is RF?

RF is an abbreviation for “Radio Frequency” and is used to describe the range of spectrum utilized for many types of wireless transmissions, including radio, television, mobile phones, remote controls, and wireless microphones. The term “Radio” in its most basic definition is the transmission of electromagnetic waves through space. These electromagnetic waves can vary in length and amplitude and occur naturally all around us. The wavelength is the physical distance between the start of one cycle and the start of the next cycle as the wave moves through space. The rate of the wave is measured in Hertz (abbreviated Hz), or cycles per second. This is called the “Frequency” of the electromagnetic wave. Figure 1 shows a basic guide of electromagnetic waves and their respective frequencies, with radio waves broken out into the lower part of the figure.

RF Transmission

Radio waves can be used as a method for transmitting information. The most common method used for transmitting analog audio via RF is with Frequency Modulation, or FM. The radio frequency being transmitted is called a carrier wave. This carrier’s frequency is modulated up and down depending on the amplitude of the audio. This technique is used in FM broadcast radio, and in analog wireless microphones.

Figure 2 gives a visual representation of a carrier wave modulated by an audio wave.

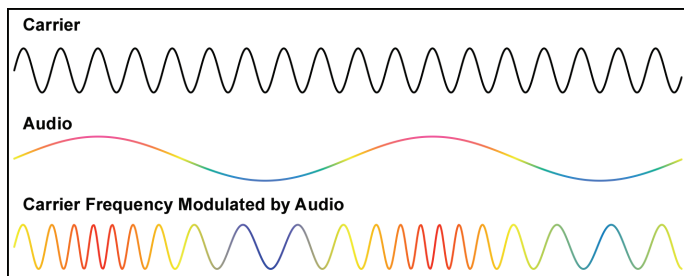

Figure 2 FM of a radio wave by an audio signal (proportions scaled for graphic clarity)

For the transmission of digital audio, a number of different techniques exist, but they share in the principle that the carrier’s frequency (and sometimes phase) is altered based on the data to be transmitted. A common example of transmitting digital signal (“ones” and

“zeroes”) is a form of frequency modulation called Frequency Shift Keying (FSK). The frequency of the carrier is shifted to represent a bit of data, as shown in Figure 3.

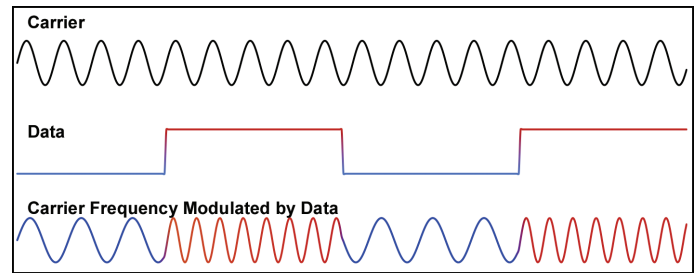

Figure 3 FSK of a radio wave by a data signal

Additional types of modulation of frequency and phase of a carrier can enable several bits of data to be transmitted within one portion of the carrier, allowing for more efficient transfer of data over the air.

RF Reception

In order to recover the audio or data signal from the carrier, the receiver needs to demodulate the frequency modulation of the carrier. A number of different techniques exist for performing this function. The details of this process will not be covered in this paper, but can be explored further in other RF technology literature if desired.

Radio Operation

Choosing a Frequency

In the US, radio frequency usage is governed by the Federal Communications Commission. Similar agencies regulate communications in most other countries.

The FCC designates what frequencies can be used by whom, as well as how much power (in Watts) can be broadcast.

Television is broadcast using radio waves with typically hundreds of thousands of Watts of power.

Wireless microphones, WiFi hubs, and other portable wireless devices typically transmit with less than one Watt of power.

In the UHF radio spectrum, the allocation of frequencies is shown in the following table:

Frequency	Usage
300MHz – 470MHz	<i>Miscellaneous Use</i>
470MHz – 698MHz	TV Channels 14 – 51
698MHz – 806MHz	Auctioned Channels
806MHz – 902MHz	<i>Cellular, public safety</i>
902MHz – 928MHz	Unlicensed ISM Band
928MHz – 944MHz	<i>Miscellaneous Use</i>
944MHz – 952MHz	<i>Broadcast Auxiliary</i>
952MHz – 2.4GHz	<i>Miscellaneous Use</i>
2.4GHz – 2.4835GHz	Unlicensed ISM Band
2.4835GHz – 3GHz	<i>Miscellaneous Use</i>

UHF analog wireless microphones typically operate in the broadcast TV range designated as channels 14 through 51 (in the USA). Many devices also exist that operate in the band that previously occupied TV channels 52 through 69 (also known as the “700MHz band”), but as of 2009 these frequencies were auctioned for commercial use and public safety, and can no longer be used for wireless microphones.

Some analog wireless systems have been designed to operate in either of the two ISM bands (named for their general usage in Industrial, Scientific, and Medical applications, although not limited to these areas). However, for analog wireless to operate with minimal problems, it needs to occupy an unused frequency band. This makes the ISM bands problematic, since other usage might interfere with their operation. (This is not a problem for digital data, which will be described later.)

The TV bands are used for digital broadcast television, which can overwhelm the power of a wireless microphone’s signal. But since not every broadcast channel is currently used in every city, there are potentially open areas available, commonly referred to as “white spaces”. This term comes from the “white” screen of “snow” (noise) that would appear on a TV if it was tuned to an unused channel.

For a wireless microphone to function in the TV bands, a white space frequency must be selected. This varies from city to city, depending on which TV channels are in use. For example, here are the channels used in Los Angeles:

14-16	<i>Reserved for Public Safety</i>	
18	KSCI-DT	Long Beach, CA
20	<i>Reserved for Public Safety</i>	
24	KBEH-DT	Oxnard, CA
28	KCET-DT	Los Angeles, CA
29	KFTR-DT	Ontario, CA
31	KTLA-DT	Los Angeles, CA
32	KDOC-DT	Anaheim, CA
33	KTBN-DT	Santa Ana, CA
34	KMEX-DT	Los Angeles, CA
35	KRCA-DT	Riverside, CA
36	KNBC-DT	Los Angeles, CA
37	<i>Reserved for radio astronomy</i>	
38	KPXN-DT	San Bernardino, CA
39	KVEA-DT	Corona, CA
41	KLCS-DT	Los Angeles, CA
42	KWHY-DT	Los Angeles, CA
43	KCBS-DT	Los Angeles, CA
47	KAZA-DT	Avalon, CA
48	KOCE-DT	Huntington Beach, CA
49	KJLA-DT	Ventura, CA
51	KXLA-DT	Rancho Palos Verdes, CA

This leaves the following channels and frequency ranges currently available:

17	488MHz – 494MHz
19	500MHz – 506MHz
21-23	512MHz – 530MHz
25-27	536MHz – 554MHz
30	566MHz – 572MHz
40	626MHz – 632MHz
44-46	650MHz – 668MHz
50	686MHz – 692MHz

According to FCC records however, all of these remaining channels have applications pending for new TV stations.

Typical analog wireless systems have selectable channels, but cover only a part of the UHF range (usually from 18MHz to 60MHz wide). Each city has its own UHF channel usage assignment, so it is important to be familiar with what channels are available prior to purchasing an analog wireless system to be sure its range is assignable to an unused TV channel. For example, a wireless system with a tunable range of 572MHz to 590MHz (channels 31 through 33) would not be suitable for use in Los Angeles.

Until now, the FCC has always required a license to use wireless microphones within any of the UHF TV channels, as described in Part 74 Subpart H of Title 47 of the Code of Federal Regulations.

For the time being the FCC is allowing wireless microphones to be used without a license under part 15 rules that restrict power levels and require them not to interfere with licensed users as well as accept interference from those licensed users of the band. The rules are expected to be revised after June 2010.

Beginning in 2010, new TV Band Devices (TVBDs, previously called White Space Devices, or WSDs) are expected to enter the market and take advantage of a recent FCC ruling allowing unlicensed use of white space spectrum not assigned to TV broadcast in that area. It is expected that TVBDs will provide services like extended WiFi and in-home wireless video. These devices are required to monitor the radio waves once per minute to detect if a wireless microphone is present and to avoid that frequency if detected, although it is not yet clear how effective this technique will be in limiting interference with analog wireless microphones.

Line 6 digital wireless microphone systems operate in ISM bands. These bands do not require a license, and are free from high powered interference such as broadcast TV.

As a result they are also free of geographical restrictions and can operate on all channels worldwide without the need to determine what commercial broadcast TV channels are operating nearby.

They do, however, have to coexist with other users of these bands. In the 900MHz range, this typically includes some cordless telephones and other low power remote applications. The 2.4GHz range also includes WiFi and Bluetooth communication. But since all of these devices are transmitting data as opposed to analog audio, the spectrum can be effectively shared with multiple devices. Unlike analog transmission, digital data is coded for the specific recipient of that data and all other data is ignored. This also applies to WiFi communication, which can support dozens of computers all in the same room without worry that one will receive information intended for another.

Radio Interference

Anyone familiar with a traditional FM radio has experienced many types of interference artifacts. When two radio stations are close together in frequency, it is sometimes possible to hear a combination of both at

the same time. Or when manually tuning a radio to a frequency that is not broadcasting, noise can be heard as a result of the spurious electromagnetic waves that are always around us.

In analog wireless microphones, any interference that causes audio artifacts can disrupt a performance. Causes of interference include obstructions (people, walls, equipment), radio wave reflections (causing multiple paths of the signal to be received), and TV channels.

Any interference that alters the reception of the audio modulation of the carrier can produce unwanted audio artifacts. One way that analog wireless attempts to reduce spurious radio waves from being turned into audio is the use of a pilot tone and a squelch circuit.

The squelch circuit's main purpose is to mute ("squelch") the audio output when the transmitter's signal is not being received. Without this, the receiver would output high amplitude noise due to the random radio waves it is receiving. But when the transmitter signal is being received, the system needs some method to attempt to differentiate the wanted signal from any interfering signal. One method is to have the transmitter always transmit a pilot tone along with the audio. This tone is usually at a very high audio frequency, and is filtered out before the audio is output from the receiver. If the receiver does not see the pilot tone at the expected level, then the squelch circuit is turned on to mute the audio. Since modulated tones can be created due to interference, spurious audio is still able to pass through the system in certain circumstances.

Digital wireless microphones, like all digital transmission systems, rely on data being "correct", that is, a zero is always a zero, and a one is always a one. However, noise or interference on the signal will not have an impact on the receiver's interpretation of the data unless it is significant enough to make the data unreadable.

When an analog audio signal has noise or interference, the result becomes audible because it is combined with the intended audio waveform, as shown here:

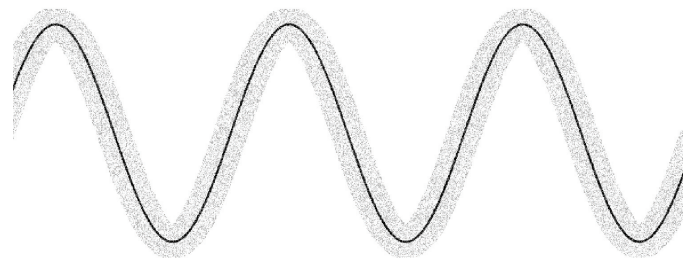

When a digital signal has noise or interference up to a certain level, the data can still be properly interpreted as ones and zeroes without any alteration in the audio, as shown in the next diagram:

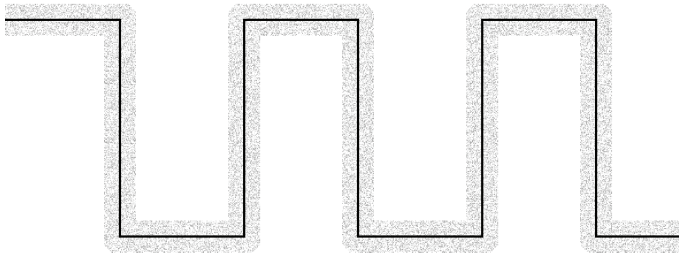

The low and high signals (zeroes and ones) can still be read without any audible artifacts.

Significant radio interference can impact a digital receiver's ability to correctly interpret the zeroes and ones. But digital has the advantage of being able to include additional information to help the receiver know if the data is correct. This is called error detection, and is commonly used in most digital storage or communication systems. This is usually performed by adding additional data to each packet of information that can be mathematically checked to validate the whole packet of data as being good or bad.

For a simple example, if the numbers 3 and 5 were to be transmitted, and along with them their sum (8) was also transmitted, the receiver could check that the two numbers received add up to the third number to be sure that the data was received correctly. If the numbers don't add up, then error correction or concealment can be deployed (these techniques won't be discussed here, but use additional transmitted data to reconstruct any data that is lost).

These types of techniques are used on CDs and DVDs, and explain why a disk can have a significant scratch and still be playable without errors. Additionally, digital systems can encode their data so that other digital signals in the same band cannot be misinterpreted as the intended data. The only data that will be read is the data intended for that receiver.

Radio Distance

The further away a transmitter is from its receiver, the lower in level the transmitter's signal is to the receiver. As distance increases, the signal to noise ratio of the radio waveform gets worse.

In analog wireless systems, this weakened signal can result in increased audio noise coming out of the receiver since the radio quality directly impacts the audio quality.

In digital wireless systems, the audio quality remains constant throughout the distance range, since the level of noise on the digital signal does not affect the analog audio signal.

Diversity

The term "true diversity" is often used to describe a feature of many analog wireless systems that utilize two antennas and two receiver circuits. Since the two antennas are spaced apart, they pick up the RF signal relative to their respective location. When the signal at one antenna is weak (due to an obstruction or multipath interference), the signal at the other antenna may not be as affected. These wireless systems have circuitry that selects the audio signal from the receiver that has the stronger signal. Switching noise is encountered, but is usually low enough to not be disruptive.

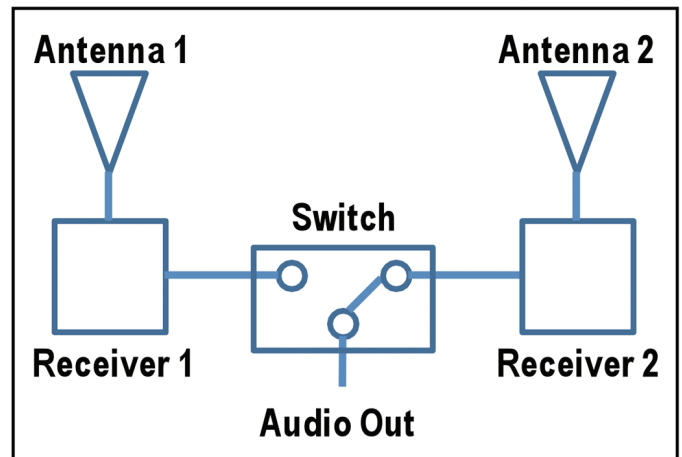

Digital systems use a similar approach to this type of diversity (also known as "spatial" diversity). Two antennas and two receiver circuits are used, but instead of switching the audio, the digital data from both receivers is compared and the one with the fewest errors detected is used. Since the data is received and buffered on both receivers, the decision of which data to use can happen continuously and without any interruption of audio from the switchover.

An additional diversity that Line 6 Digital Wireless systems provide is Frequency Diversity. Frequency diversity utilizes multiple RF carrier frequencies to carry different parts of the audio data. This significantly reduces the impact of other RF signals, since the interference is not likely to be present on all of the frequencies being used.

The result of the error detection, frequency diversity, and data coding properties of digital wireless allow Line 6 2.4 GHz wireless systems to operate in heavily congested RF environments without the necessity of a

clear channel while ensuring that the only audio that will ever be passed through the receiver is the intended audio from the transmitter.

Choosing a Channel

In many analog wireless systems, each uniquely selectable frequency is called a “channel”. This terminology can be misleading, since most of these channels typically cannot be used at the same time. Analog wireless frequencies need to be spaced apart, typically by at least 1MHz, in order for them to operate with minimal interference. But selectable channel frequencies on many devices can be spaced as close as 25kHz from each other. Fine resolution of tuning is provided in order to make it more likely to find frequencies that have minimal interference. Due to the space needed between simultaneously operating channels, the number of actual usable channels is about ten times less than the number of frequencies that are selectable.

Most analog wireless companies provide software or web-based tools to help the user select an appropriate frequency. Since most affordable devices do not display the TV channel or frequency in MHz, it is necessary to refer to these tools in order to know which group and channel is an appropriate choice for the area. Some models provide a scan function that will select a frequency that is available for wireless use. This can also help in selecting a channel, presuming that the device’s frequency range extends into areas not occupied by local TV stations.

Additionally, channel selection needs to be considered any time the device is to be used in a different city, due to the variations in TV channel usage throughout the country.

In digital wireless systems operating in the ISM bands, all channels are always available. This is because there are no competing high powered transmitters permitted in this space. The total number of channels selectable is the number of channels that can be used simultaneously. Additionally, ISM bands are usable throughout the world regardless of the local TV channel assignments.

Audio Transmission

Due to FCC regulatory bandwidth limitations, analog FM has a less than ideal dynamic range and frequency response for transmitting audio signals. These inadequacies require analog FM wireless microphones to perform signal processing on both the transmitter and receiver.

Dynamic Range

Dynamic range is defined as the loudness difference (in decibels, or dB) between the softest and loudest signals possible in a system.

The typical dynamic range of an unprocessed audio signal transmitted via FM is about 50dB. This is because the audio dynamic range is directly proportional to the amount of frequency modulation that can be applied to the carrier, and the amount of modulation is limited so it won’t overlap into adjacent frequency bands.

In order to achieve 100dB of dynamic range, which is considered to be a minimum for high quality audio, an analog wireless microphone compresses 100dB of input dynamic range by a ratio of 2:1 in order to have it fit within 50dB. This compression is achieved by using a “VGA”, or Variable Gain Amplifier, with its gain being adjusted as a function of the average signal level being input. Louder signals are reduced in level, and/or softer signals are increased in level, so that the overall dynamic range is smaller.

On the receiver side, expansion is required, again using a VGA, in order to attempt to restore the original dynamic range. In this case, louder signals are made louder, and or softer signals are made softer, such that the original dynamic range is restored. The combination of these two processes is known as “companding” (a combination of compressing and expanding).

Unfortunately, companding does create some sonic artifacts. Depending on the time constants used to analyze the signal level and “decide” on the gain the VGA is set to, gain changes can become audible, creating a sound often called “breathing”. This can be heard most obviously when a loud transient sound occurs, causing the VGA gain to quickly reduce level to compress the signal. After the transient has passed, the VGA gain is gradually returned to “normal”, during which time any other sound or noise can be heard to increase in volume, or breathe. Additionally, the expander on the receiver has no knowledge of the original input signal, so its ability to restore the original dynamic range is dependent on the manufacturer’s accuracy of matching the time constants and gain control between the transmitter and receiver.

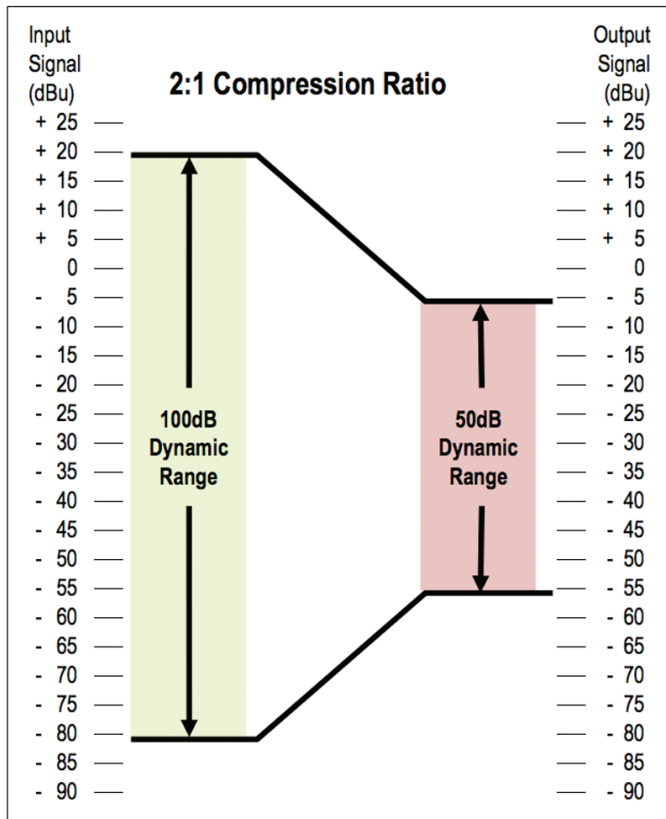

The result is a reduction in the residual noise present in analog FM wireless systems, but at the cost of reduced dynamic range in higher frequencies due to the higher gain of these frequencies at the transmitter.

Digital wireless systems are able to transmit the digital audio signal without any compression or limiting, or Pre-emphasis/De-emphasis. It also can accommodate a wider input dynamic range, eliminating the need for level controls. The result is that the input signal is accurately reproduced at the receiving end.

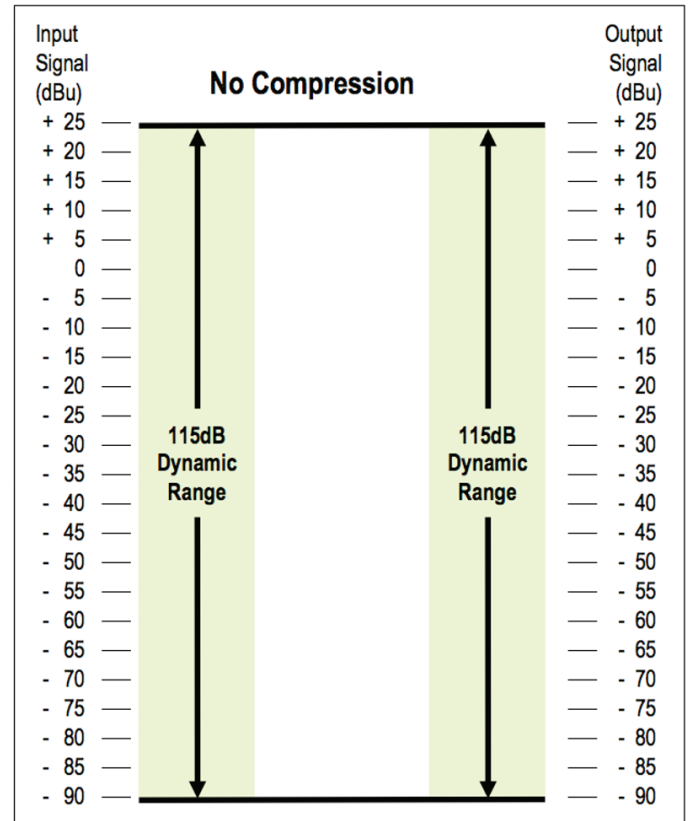

Additionally, the dynamic range of the original audio signal can exceed 100dB. In order to accommodate this, the transmitter usually has a user adjustment for level control. If a singer is clipping the input, then the transmitter’s signal level must be adjusted downward, and the receiver’s level must be proportionally adjusted upward to maintain unity gain. Typical FM transmitters will also include an additional audio processing section called a “limiter”. This function prevents an overload condition of the audio signal which can cause distortion. The limiter also prevents “overmodulation” (excessive frequency deviation) of the RF signal. Overmodulation results in the RF signal deviation exceeding the bandwidth of the receiver, resulting in additional distortion. The limiter prevents the audio signal from exceeding a preset maximum level.

Dynamic range in analog systems is further reduced in high frequencies due to a technique called Pre-emphasis/De-emphasis. Pre-emphasis is the act of boosting high frequencies in the audio band and De-emphasis is the act of cutting high frequencies in the audio band. These methods are used to improve signal to noise during transmission. The boosted high frequencies produce a larger deviation of the RF carrier thus creating a larger signal compared to the existing RF noise floor. Once the signal is received, the De-emphasis reduces the high frequencies, also reducing noise in the process.

Distortion

The term Distortion is used to describe any nonlinearity in a system, which can result in altering the intended sound. The nature of companders introduce a nonlinearity that results in an increased level of distortion. Additionally, high level signals can cause overmodulation distortion. Most analog wireless systems specify their Total Harmonic Distortion at a level in which the compander is steady and no overmodulation can occur. In these conditions, the THD specification is typically 0.1% to 0.5%.

In a digital wireless system, the distortion is a function of the overall linearity of the system. There is no compander, nor any audio overmodulation possibility. The signal remains linear throughout the dynamic range,

resulting in a typical Total Harmonic Distortion specification of 0.03%, an order of magnitude improvement.

Frequency Response

The frequency response of an analog wireless system is limited at both the low and the high end. On the low end, it is necessary to roll off frequencies that would interfere with the companding circuitry. For example, a frequency of 20Hz is slow enough to cause the gain to change with each cycle of the waveform. Therefore, low frequencies are filtered out. The high frequencies are limited by the constraints of analog FM technology, which typically cannot produce frequencies above 15kHz. The following graph shows the wireless frequency response of two popular brands:

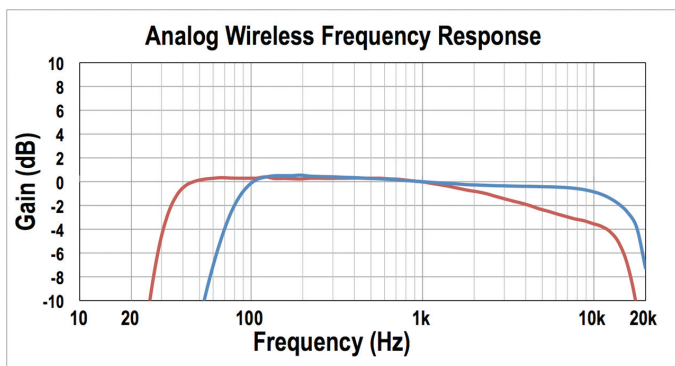

The high frequency response of a digital wireless system is a function of the sample rate, and not any aspects of the RF transmission.

Also, since there is no compander, the low frequencies do not need to be rolled off. As a result, a digital wireless system can transmit signals flat between 10Hz and 20kHz.

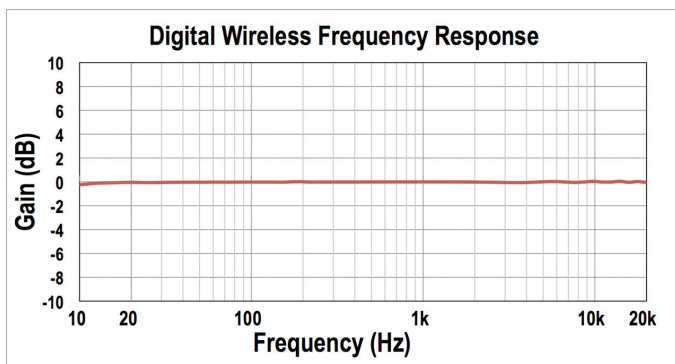

These graphs represent the frequency response of the wireless systems, independent of the microphone element frequency response. Each microphone has its own tonal response, which can determine the character of its sound. If a wireless system has a flat frequency

response, it allows the characteristics of the microphone's response to remain unaltered.

Summary

Line 6's digital technology brings a number of advantages to the world of wireless microphones. By overcoming the limitations of analog systems, wireless can now be used with all the reliability, ease, and sonic benefits of a wired microphone.

Digital Benefits

- *Ultra-Simple set up and use*
- *No interference from broadcast TV*
- *No frequency coordination per location*
- *All 2.4GHz channels work world-wide*
- *No license required*
- *No Pre-emphasis/De-emphasis*
- *No companding*
- *No limiting*
- *No gain, pad or squelch adjustments required*
- *>115dB dynamic range*
- *10Hz – 20kHz frequency response*
- *0.03% Total Harmonic Distortion*
- *Audio quality unaffected by RF interference*

QUALITY COUNTS

CHOOSE DIGITAL



Digital wireless is better. And Line 6 X-DV digital wireless microphone systems are exceptional. Each one delivers unmatched wireless performance, simplicity, and sound on every stage around the world – license free. Our 4th-generation digital technology makes sure of it. You can put your faith in ancient analog technology, or you can simply choose digital.

X-DV Digital Wireless Systems

Make the right choice at line6.com/wireless-microphone



X-DV BELTPACKS



X-DV30



X-DV70



Over a decade of digital innovation