



HELIX NATIVE

PILOT'S GUIDE ►

A guide to the features and functionality of the Line 6 Helix Native plug-in

Contents

Welcome to Helix Native Plug-in	3	Presets Panel	20	The Edit Tab	40
Requirements and Installation	3	Helix Native Factory Presets	20	Selecting Models	40
Purchasing the Software License	5	Premium Marketplace Presets	21	Availability of Models within the Model Browser	40
Authorizing your Computer	5	Loading Presets	21	Editing Model Parameters	41
Workflow	7	Importing and Exporting Helix Preset Files	21	Note Sync	41
About Plug-ins	7	Renaming, Reordering, Copying and Pasting Presets	22	Editing Input, Output, Split & Merge Blocks	42
What's in it for Me?	7	Importing and Exporting Setlists	22	Editing Send, Return, FX Loop & Looper Blocks	42
Marketplace	7	Importing and Exporting Helix Bundles	23	The Automation/Controller Assign Tab	43
Quick Start	8	Impulses Panel	24	About Plug-in Parameter Automation	43
Live Input Monitoring Through Helix Native Plug-in	10	What are Impulse Responses?	24	Controller Assignment for Automation	44
Optimizing the Input Level	10	Importing and Exporting Impulse Responses	24	Editing Options for an Existing Automation Controller Assignment	46
GUI Overview	11	Renaming, Loading, Copying, and Clearing IRs	25	Removing or Replacing an Existing Automation Controller Assignment	47
Customizing the Helix Native Plug-in Window	11	Working in the Plug-in Editor	27	MIDI Bypass & Controller Assignment	49
Undo / Redo	12	Navigating with the Next/Previous Preset Buttons	27	Setlist, Preset, and Snapshot Recall via MIDI	51
A / B Compare	12	Using the Preset File Menu	28	Global Reserved MIDI CCs	52
Status Bar Controls	12	Undo and Redo	28	Preferences and About Box	54
Preset Compatibility with Helix and HX Devices	13	Using the A/B Compare	29	The Preferences Window	54
Loading vs. Importing Presets into Helix Native	13	Editing the Tempo	30	The About Box and Help Options	56
Hardware Compatibility Modes	13	Working with Snapshots	31	Marketplace & Account Options	58
Preset Translation	15	The Snapshots Menu	31	Marketplace	58
Preset Compatibility with Helix and HX Devices	16	Snapshots > Block Bypass	31	The My Account Menu Options	59
HX Edit Application	16	Snapshots > Parameter Control	32	Account Sign In / Sign Out	59
Input & Output Block Settings	17	The Signal Flow Window	34	Authorize / Deauthorize your Computer	60
Hardware Blocks (Send, Return, FX Loop & Looper)	17	Master Input & Output Level Controls	34	Model Lists	61
Impulse Responses	18	Adding, Clearing & Bypassing Blocks	35	Effects Models	61
Hardware Controller Assignments	18	Cutting, Copying & Pasting Blocks	35	Amp Models	66
Computer Processing Management	19	Drag and Drop Blocks	36	Speaker Cabinet Models	68
		Block Order and Stereo Imaging	36	Microphone Models	69
		Moving Blocks & Arranging the Signal Flow	37	Additional Resources	71
		Signal Routing Examples	38		

© 2020 Yamaha Guitar Group, Inc. All rights reserved.

Line 6, the Line 6 logo, Helix, HX Stomp, HX Effects, M13, M9, M5, DL4, DM4, MM4, FM4, Ampeg, SVT, and Portaflex are trademarks or registered trademarks of Yamaha Guitar Group, Inc. in the U.S. and/or other jurisdictions. Apple, Mac, OS X, macOS, and Logic Pro are trademarks of Apple, Inc., registered in the U.S. and other countries. Windows is a registered trademark of Microsoft Corporation in the United States and/or other countries. Cubase and VST are registered trademarks of Steinberg Media Technologies GmbH. Avid and Pro Tools are registered trademarks of Avid Technology, Inc.

Welcome to Helix Native Plug-in

Thank you for purchasing the Line 6® Helix® Native software, one of the most powerful and flexible native, multi-processing audio plug-ins ever created. Not just for guitarists, the Helix Native plug-in is also ideal for producers and engineers, sound designers, film/TV/game composers, electronic musicians, and anyone else seeking to craft new and exciting sounds and special effects. This guide covers the features & functionality of Helix Native plug-in v1.90.

The Helix Native plug-in truly is the same set of astounding amps, cabs & effects as included within the ground-breaking Line 6 Helix® hardware multi-effects units, and shares the same simple user interface and workflow as the Line 6 *HX Edit* editor application for Helix family devices.* Due to this design, all presets you create in Helix Native plug-in are compatible and transferable to Helix hardware units via the HX Edit application, so you can take your presets from studio to the stage—and back again! We hope it helps drive your search for tonal bliss and spawns years of creativity.

HELIX NATIVE

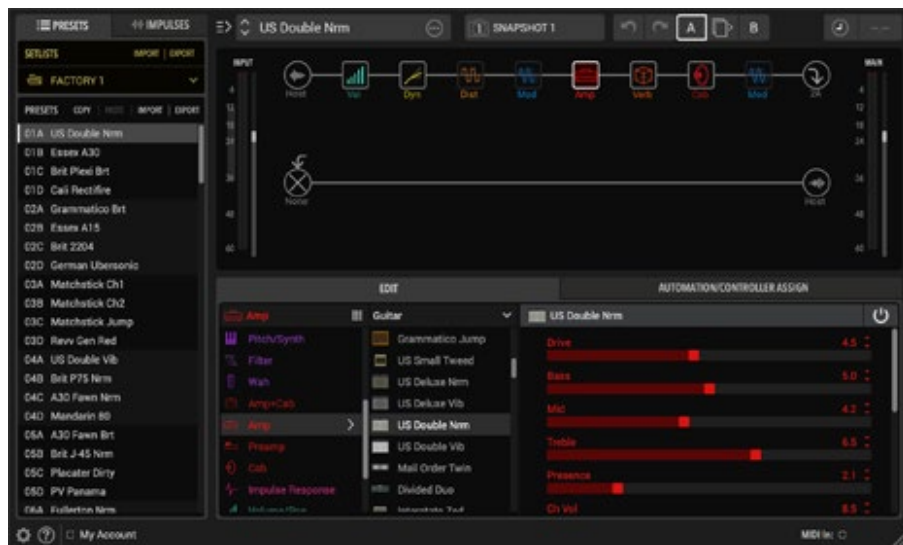

The Helix Native plug-in

***NOTE:** Presets can be shared between the Helix Native plug-in and all Helix and HX devices—please see [“Preset Compatibility with Helix and HX Devices” on page 13.](#)

Requirements and Installation

Ready to jump in? The latest Helix Native installer for Mac & Windows® computers can be downloaded anytime from line6.com/software. Once installed, a free 15-day trial is available, allowing you to fully try the software on your system. After 15 days, you are required to purchase and authorize the Helix Native plug-in to continue using it on your system. Please check the requirements below to make sure your computer and DAW software meet the minimum requirements.

System Requirements

To follow are the requirements to install and use the Helix Native software on your DAW computer system. Note that Helix Native is a 64-bit plug-in and, therefore, requires that your host DAW application supports 64-bit plug-ins.

Mac Computers:

- Mac OS X 10.10 and 10.11, and macOS 10.12 and later
- 64-bit AAX Native, Audio Units (AU), VST® (VST2 or VST3) host DAW software
- Supported sample rates: 44.1kHz, 48kHz, 88.2kHz, and 96kHz

Windows Computers:

- Windows 7 SP1, Windows 8.1, and Windows 10 (64-bit versions only)
- 64-bit AAX Native, VST (VST2 or VST3) host DAW software
- Supported sample rates: 44.1kHz, 48kHz, 88.2kHz, and 96kHz

Minimum Hardware Requirements

- Dual-Core 2.0GHz processor or faster
- 4GB of RAM
- 100MB of free disk space
- Internet connection required for license authorization, use of trial version, and for the initial license synchronization of Marketplace premium assets. (The use of premium presets and Impulse Responses purchased from Marketplace requires Helix Native version 1.70, or later)

Installing the Helix Native Plug-in



The first step is to sign in to your **Line 6 User Account**. If you don't already have one, just go ahead and create one now at line6.com/account—all the cool kids have one, and it's free! Then follow the steps below.

NOTE: An Internet connection is required for the computer on which you want to install and run the Helix Native trial version, as well as for license authorization & deauthorization. License authorization on your computer is required for the use of Helix Native plug-in and for the import & export of purchased Marketplace premium assets. See [page 5](#).

NOTE: The use of premium presets and IRs from the Line 6 Marketplace requires Helix Native version 1.70 (or later). Once Helix Native 1.70 has been installed, it is necessary to uninstall Helix Native before installing any earlier Helix Native version (see [“Removing Helix Native Plug-in” on page 6](#)).

1. Once signed in, you can head directly to the Line 6 Online Store and purchase your Helix Native license (see [“Purchasing the Software License” on page 5](#)), or proceed to the next step to install the Helix Native software on your computer and optionally choose the 15-day free trial.
2. Proceed to the line6.com/software page and download the Helix Native installer for your Mac or Windows system.



The Line 6 website's software downloads page

IMPORTANT! Before installing Helix Native plug-in, or any Line 6 application, device drivers, or firmware, it is highly advised to first read the product's **Release Notes** (typically available on the Line 6 Software Downloads page, within the product's download description). It is also advised to check the [Knowledge Base and FAQs](#) regarding updating to new versions, or especially for rolling back to older versions, since special install instructions may apply.

3. Once the download completes, exit your host DAW and all other applications, then run the installer and read and follow its steps to complete the installation (yes, we do recommend reading those screens before just clicking to the next!). If desired, you can customize the installation to install only the format(s) you require (AAX, AU, VST3 or VST2) for your particular host DAW application.*

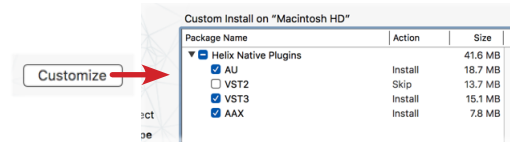

Mac - Custom install options
(click the Customize button to access options)

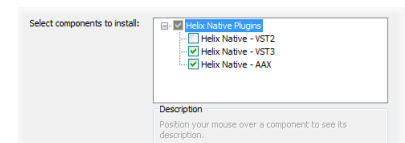

Windows - Custom install options



***NOTE:** If your host DAW application supports VST3, it is recommended that you do not also install the older VST2 format (VST2 is not selected by default). The VST2 format is offered for users that have host DAW applications that do not yet support VST3 plug-ins.

On Windows installation, if you do choose to install VST2, you'll be prompted to enter a custom install location. Please take note of the VST2 install location you choose since your host DAW may require that you manually define this VST2 directory within its Preferences to allow its VST2 scan to find it.

4. Once the installation is complete, simply launch your host DAW application and it will typically scan and find the Line 6 Helix Native plug-in and list it within its audio plug-in insert menus.
5. Insert the Helix Native plug-in on a track within your DAW project (see [“Quick Start” on page 8](#) for help, if needed). You'll initially see the license authorization screen.
 - **If You Have Already Purchased a Helix Native License** - You'll be prompted to authorize the computer for this license—please skip ahead to [“Authorizing your Computer” on page 5](#).
 - **If You Have Not Yet Purchased a Helix Native License** - You can either choose to purchase now (see next section), or start a 15-day free trial. Once the trial expires, it is necessary to purchase and then authorize the computer with which you will be using Helix Native, or the plug-in will no longer be functional.

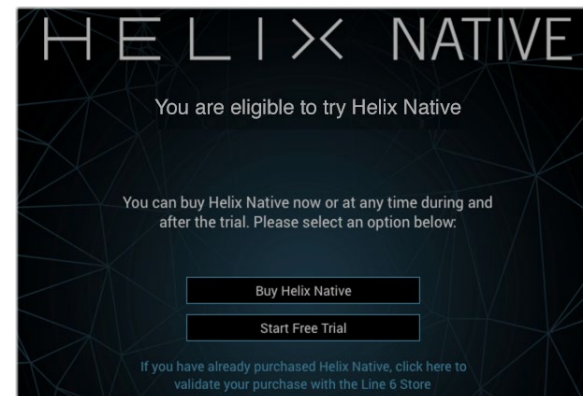

Helix Native plug-in's purchase & trial mode options

NOTE: Once you've started the free trial version, you'll see your remaining trial time displayed at the bottom right of the plug-in window.

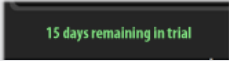

15 days remaining in trial

Trial status indicator

You can purchase a Helix Native license online at any time during or after your trial period by simply clicking on this trial status indicator, or going directly to the Line 6 Online Store at <https://shop.line6.com/>.

Purchasing the Software License

The Helix Native license is available for purchase from the [Line 6 Store](#).^{*} Just add Helix Native to your shopping cart, checkout, and, through the power of the Interwebs, the license will be immediately deposited into your Line 6 User Account. Alternatively, you can first download and install the Helix Native software and then choose to purchase or run it as a free trial first (see [“Installing the Helix Native Plug-in” on page 4](#)). Once you've purchased the Helix Native license, you then use the plug-in's Authorization screen to authorize your computer to run Helix Native, as covered in the following section.

***NOTE:** Helix Native may also be available from your favorite music gear retailer. If purchased from one of these vendors, your purchased Helix Native license will be automatically deposited into your Line 6 account as part of the process.



NOTE: If you are the registered owner of a Line 6 Helix or HX device, or POD Farm software, you may qualify for a substantial discount on the purchase of Helix Native! Please see the purchase options on the Line 6 Store.

Authorizing your Computer

Before you can use Helix Native, your computer on which you will be running the plug-in must be authorized for your purchased Helix Native license. Authorization is accomplished within the plug-in's built-in Authorization screen, via an Internet connection directly from your DAW computer. Once you've installed the Helix Native software, launch your host DAW application, insert an instance of the Helix Native plug-in on a track and launch the plug-in window. (Please see [“Quick Start” on page 8](#) for help on how to insert Helix Native plug-in within a host DAW.)

1. **Sign in** - Once launched, the Helix Native Authorization screen is displayed, prompting you to sign in using your Line 6 User Account username and password. (Note that your username is typically the name you created when creating the account and *not* your email address!)

NOTE: Once a Helix Native license is purchased and your computer is successfully authorized, you will no longer be prompted to sign in on each use. Being actively signed in is then only necessary to deauthorize and authorize your computer, and for the initial synchronization of licenses for newly purchased Marketplace assets.

Your computer must be in the “authorized” state to be able to import and export and utilize any premium assets purchased from the online Marketplace for use within Helix Native. If you plan on purchasing Marketplace premium assets, it is easiest just to remain signed in and authorized within Helix Native—this allows all your assets fully functional, and their licenses to remain synced. Please also see [“Marketplace & Account Options” on page 58](#).

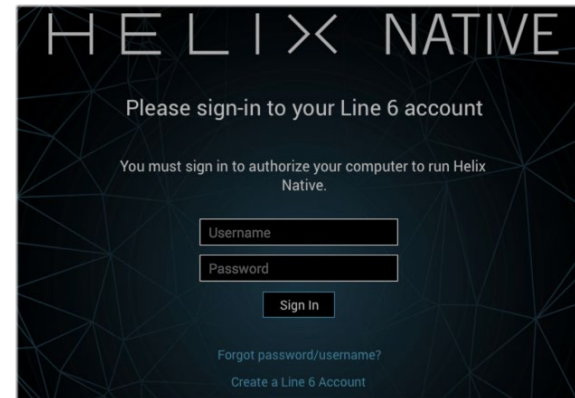

The initial Helix Native Authorization - Sign In Screen

- **If You Have an Existing Line 6 Account but Forgot Your Login** - Click the **Forgot password/username?** option and follow the steps to reset your login credentials.
 - **If You Don't Yet Have a Line 6 Account** - Click the **Create a Line 6 Account** link to create one. Or you can do that right now by going [here](#)—it's free!
2. **Enter your username and password and click Sign In to proceed.**
 - **If You Have Already Purchased a Helix Native License with this Line 6 Account** - Upon signing in, select the **Authorize Computer** option and you should see confirmation that your computer is now successfully authorized.* You can now start using Helix Native!

- **If You Have Not Yet Purchased a Helix Native License** - You'll be informed that no license was found on your Line 6 account, and you'll have the option to buy it now, or start a free trial.

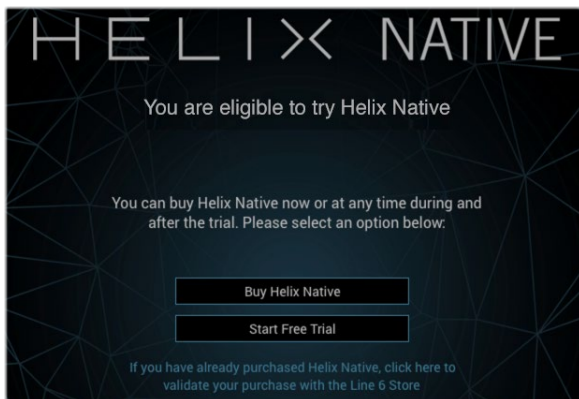

Helix Native plug-in's purchase & trial mode options

***NOTE:** Be sure to Sign In using the same Line 6 Account you used when making the Helix Native license purchase!

- **To Purchase a Helix Native License** - Click the **Buy Helix Native** button and follow the steps on the secure Line 6 Online Store. Once complete, a Helix Native license will be deposited into your Line 6 account. Your purchased license will be found and Helix Native plug-in will authorize on your computer.
- **To Use Helix Native in Trial Mode** - Click the **Start Free Trial** button and you'll be able to use the Helix Native plug-in without restriction on this computer for 15 days (an active Internet connection is required for the Trial Mode). You may be prompted to sign in for each session when using Helix Native in trial mode. After the trial period expires, Helix Native will no longer be functional unless you choose to purchase the Helix Native license.

***NOTE:** Once you've started the free trial version, you'll see your trial time remaining at the bottom of the plug-in window. Click directly on this indicator if you wish to purchase your Helix Native license.

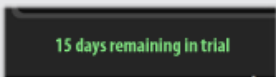

Deauthorizing - Moving to Another Computer

Once you have purchased the plug-in license and authorized your computer (or if using the free trial version), if you wish to run Helix Native plug-in on a different computer, it may be necessary that you first deauthorize your current computer.*

To deauthorize, click on the My Account menu at the lower left of the plug-in window to Sign In to your Line 6 account, then choose **Deauthorize Computer** from this menu. (Also see [page 60](#)).

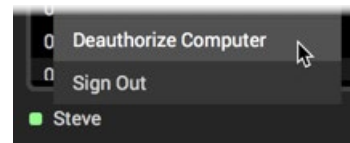

Selecting Deauthorize Computer from the My Account menu

Once you've deauthorized the computer, you can authorize it again at any time by performing the **Sign In** to your account from the My Account menu. In this scenario, since you had previously authorized this computer, it will be automatically authorized upon a successful sign in.

***NOTE:** Line 6 generously permits you to have your purchased or trial mode Helix Native license authorized on a maximum of 4 of your own computers concurrently. To move the license to a different computer, it is necessary to deauthorize on at least one of these systems to free up an authorization to be used on another computer. For further assistance, please contact [Line 6 Support](#).

Removing Helix Native Plug-in

Should you ever desire to remove Helix Native from your computer system, first quit your host DAW application, then follow the instructions below.

***NOTE:** Before removing Helix Native, it is highly recommended to export your presets (see ["Importing and Exporting Helix Preset Files"](#)) and IRs (see ["Importing and Exporting Impulse Responses"](#)) to make sure you have backups of them.

Mac

To uninstall each plug-in format, move the following files to the Trash:

- **AU plug-in:** /Library/Audio/Plug-Ins/Components/**Helix Native.component**
- **VST2 plug-in:** /Library/Audio/Plug-Ins/VST/Line 6/**Helix Native.vst**
- **VST3 plug-in:** /Library/Audio/Plug-Ins/VST/Line 6/**Helix Native.vst3**
- **AAX plug-in:** /Library/Application Support/Avid/Audio/Plug-Ins/Line 6/**Helix Native.aaxplugin** (or, you can optionally drag the Helix Native.aaxplugin file into the /Plug-Ins (Unused) folder)

Windows

To uninstall all plug-in formats:

- Choose Start > Control Panel (or, on Windows 10, choose Settings)
- Click Programs and Features (or, on Windows 10, choose System > Apps & Features)
- Select **Line 6 Helix Native Uninstaller** from the list of installed applications
- Click Uninstall and follow the on-screen instructions to remove Helix Native

Workflow

This guide contains details of the Helix Native plug-in's features and functionality. All behaviors are the same on Mac and Windows (and for all plug-in formats—AAX, AU, VST3 & VST2) unless otherwise noted. For the most part, the many host DAW applications on the market work very similarly in respect to how you insert and utilize effects plug-ins. However, each host may have some unique features and settings you'll want to take advantage of, so be sure to read through your host DAW application's user documentation as well.

About Plug-ins

There are many types of “plug-ins” in the world of software. Plug-ins are relatively small applications that can only run when loaded inside a compatible “host” software application, extending the capabilities of the host. In the world of DAW (Digital Audio Workstation) applications, audio plug-ins provide signal processing for your audio tracks and/or live audio input.

A helpful analogy for audio plug-ins is to think of them as effects pedals. Effects pedals change the tone of your instrument before the signal reaches your amplifier. As with pedals, rack effects units, or any other conventional piece of outboard gear, plug-ins provide familiar knobs, sliders & buttons for tweaking their parameters. Plug-ins process your track signal similarly, but since they run in real-time in your DAW host software, they are non-destructive, allowing you to continue tweaking their settings all the way up until you do your final DAW project mix-down!

What's in it for Me?

Helix Native is much more than a one-trick audio processing plug-in. It allows you to combine a multitude of amps, speaker cabs and effects in practically any signal routing fashion you can imagine. Its integrated preset librarian and IR manager also allow you to easily customize, back up and manage your built-in library of tones. All is managed within its simple, but powerful, user interface. Also note that Helix Native is not just for guitar! The many included amp, preamp, delay, modulation, reverb, compressor, distortion and other effects can be utilized on any types of recordings, for traditional or other-worldly results.

If you own a Line 6 Helix or HX device, then you effectively already know how to use Helix Native plug-in! Helix Native utilizes a similar user interface as the current Line 6 HX Edit* editor application, therefore, tone creation and preset management tasks are essentially the same. In fact, you can import Helix/HX hardware-created presets and use them within Helix Native—and vice-versa!

 ***NOTE:** *HX Edit* is the newest editor application for Helix family devices that are running firmware v2.20 or later, and it replaces the previous *Helix* application, which is the recommended editor application to be used for Helix devices running firmware earlier than v2.20. For best performance, and to take advantage of all the newest features & functionality, it is recommended that you always use the latest available version of both the HX Edit application and Helix/HX device firmware. Please also see [“Preset Compatibility with Helix and HX Devices” on page 13.](#)

For those new to the Helix products family, although Helix Native plug-in may appear complex at first glance, it is designed in such a way that once you learn a few basic concepts, you'll be able to construct both simple and complex tones at nearly the speed of thought, with very little deep diving required. It's a great idea to try the included Factory & Template presets as a starting point, which you can customize as desired to start building your own Helix tone collection.

 ***NOTE:** For even more details about individual Helix family models and capabilities, please also read through the Helix hardware and software *Owner's Manuals*—available from line6.com/support/manuals.

Marketplace

Be sure to visit the [Marketplace online shop](#), where you'll find 3rd-party add-on assets that even further enhance the functionality of your Helix Native plug-in (and Helix or HX device, if you own one). Available now are professionally crafted presets and IRs that can be instantly purchased and added to your Helix Native libraries. An Internet connection is required for the computer where you'll be using Helix Native to initially sync and authorize the licenses for the use of Marketplace premium assets. Please see [“Marketplace & Account Options” on page 58.](#)

Quick Start

OK, we know you're eager to jump right in and give Helix Native a try on your tracks! To follow are steps for adding an instance of Helix Native plug-in within a host DAW application's audio track to get you up and running.

You will find Helix Native within your host DAW application's plug-in insert menus along with all other audio effects plug-ins. The initial steps in any host DAW application are as follows.

1. Create a Session or Project at a supported sample rate (44.1kHz, 48kHz, 88.2kHz or 96kHz)
2. Create at least one audio track. Depending on your host DAW application, it may offer options for "mono" or "stereo" type audio tracks, or just one common audio track type that can record or import mono or stereo audio, depending upon the hardware input type you choose for the track. Either way, Helix Native plug-in can be added into the effects insert of your audio track.
3. Either record some unprocessed "dry" electric guitar into the audio track, or import an existing recorded audio file into the track so you have something for playback.
4. Now you can proceed to insert an instance of Helix Native on this track by selecting it from the host DAW track's effects insert menu. To follow we've provided examples on several popular host DAW applications.

Steinberg Cubase

The Cubase® application is offered for both for Mac & PC. It supports the VST3 plug-in format.

1. Select your audio track within the Cubase project. Within the track's Inspector at the left of the track (or within the Cubase Mixer window's channel strip for this track), click on one of the slot's menus in the Inserts section.



Inserting Helix Native plug-in on a Cubase Pro audio track

2. In the Effects menu, choose **Helix Native**. Note that Cubase offers both mono and stereo track types. You can simply choose the Helix Native plug-in and it will conform to your Cubase track's input & output routing configuration.

NOTE: Within later versions of Cubase, when creating an audio track, the **Project > Add Track > Audio** window's **Configuration** menu allows you to choose **Mono** or **Stereo**. This Configuration setting determines whether a mono or stereo version of the plug-in is used when adding the plug-in to the audio track's Insert slots.

3. You will then see the Helix Native plug-in appear in the Effects Insert window. Be sure to turn your monitoring system to a low level, then double-click a factory preset from the plug-in's Presets tab and hit Play to hear the results.

Cockos Reaper

Reaper is a full-featured host DAW available for both Mac and PC.

1. Select your audio track within your Reaper project. Within the track header at the left (or within the Reaper Mixer window's channel strip for this track), click on the FX track effects insert menu button.

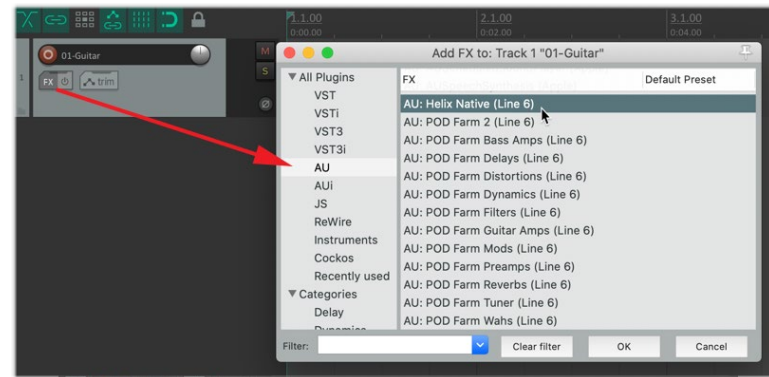

Inserting Helix Native plug-in on a Reaper audio track

2. In the FX window, click the **Add** button to open the list of plug-ins, then choose the plug-in format type. On Mac, Reaper supports both the AU (Audio Units) and VST3 plug-in formats, so you can choose either. On PC, choose VST3. Select **Line 6: Helix Native** and click **OK**.

3. You will then see the Helix Native plug-in appear in the FX window. Be sure to turn your audio monitoring system to a low level, then double click a Factory preset from the plug-in's Presets tab and hit Play to hear the results.

NOTE: Some Mac host DAW applications allow you to use instances of plug-ins of different format types (for example, in Reaper you can insert both VST and AU type instances of Helix Native within the same project simultaneously). For some actions, such as changes within the Helix Native Preset or IR Libraries and Preference options, changed settings will not take effect immediately across currently open Helix Native plug-in instances of different format types until you close and re-open the plug-in windows.

Apple Logic Pro

Logic Pro is an extremely popular host DAW for Mac. It supports the Apple Audio Units (AU) plug-in format.

1. Select your audio track within the Logic Pro project. Within the track's Inspector channel strip (or within the Logic Pro Mixer window's channel strip for this track), click on the **Audio FX** track effects insert menu.

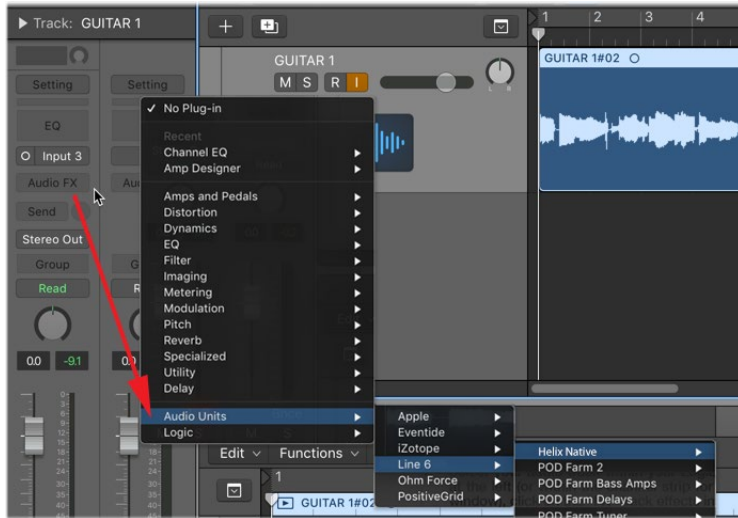

Inserting Helix Native plug-in on a Logic Pro X audio track

2. In the FX window, choose the Audio Units (AU) plug-in format type and select **Line 6 > Helix Native**. Note that Logic Pro offers both mono and stereo track types, therefore, you'll have different sub-options depending on your track's type:
 - If inserting on a **mono track** - You'll have the option to choose either **Mono** (the plug-in's output is summed to mono) or **Mono->Stereo** (the plug-in's output is stereo).
 - If inserting on a **stereo track** - It is recommended to select the **Stereo** option here, which provides stereo in/out processing. The **Dual Mono** option inserts two mono instances of the plug-in (each accessed via the L and R buttons at the top of the plug-in window). Each mono instance processes the left and right audio channels of the stereo track discretely, but this can quickly utilize a great deal of CPU power, so we don't recommend using it.
3. You will then see Helix Native appear within the plug-in window. Be sure to turn your monitoring system to a low level, then double click a Factory preset from the plug-in's Presets tab and hit Play to hear the results.

Avid Pro Tools

The Avid® Pro Tools® host DAW application for is available for Mac & Windows. It supports the Avid AAX plug-in format.

1. Select your audio track within your Pro Tools project. Within the track header at the left of the track (or within the Pro Tools Mixer window's channel strip for this track), click on one of the slot's menus in the **Inserts** section.

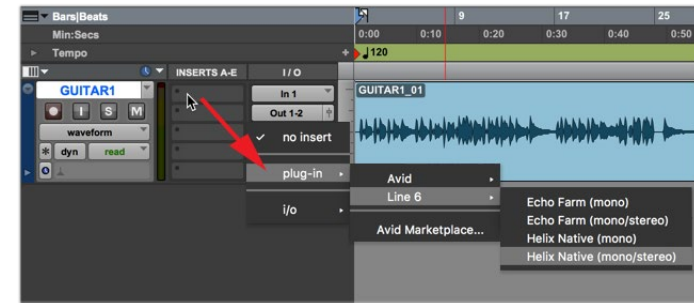

Inserting Helix Native plug-in on a Pro Tools mono audio track

2. In the plug-in menu, choose **Helix Native**. Note that Pro Tools offers both mono and stereo track types, therefore, you'll have different sub-options depending on your track's type:
 - If inserting on a **mono track** (as shown above) - You'll have the option to choose either **mono** (the plug-in's output is summed to mono) or **mono/stereo** (the plug-in's output is stereo, assuming the track is routed to a stereo output).
 - If inserting on a **stereo track** - Only a **stereo** option is offered here, which provides stereo in/out processing. (Note that Pro Tools does offer a **dual mono** option for some plug-ins, but this is not supported by Helix Native plug-in.)
3. You will then see the Helix Native plug-in appear in the Effects Insert window. Be sure to turn your monitoring system to a low level, then double-click a Factory preset from the plug-in's Presets tab and hit Play to hear the results.

TIP: Most host DAWs also allow you to insert plug-ins on Send, Bus or Aux track types. Host DAWs differ slightly in their naming and features of these track types, but their main purpose is to allow you to insert a single instance of your plug-in and then route the output of any number of audio tracks into it to process them using the same effect. This is the preferred way of processing multiple tracks since, obviously, one instance of your plug-in utilizes less CPU power as compared to inserting individual instances on each audio track! Please refer to your host DAW's documentation for details.

Once you insert an instance of Helix Native and load a preset, the preset's contents are displayed within the **Signal Flow Window**, with model menus, parameters and automation control options available within the tabs of the **Inspector Window**.

This allows you to load & customize any of the provided Factory presets, create your own presets, configure automation controller assignments, manage presets & Impulse Responses, as well as back up all your tones to your computer. Even better, all your saved creations can be transferred between Helix Native plug-in and the HX Edit application, allowing them to also be used on a Helix hardware device as well (see [“Preset Compatibility with Helix and HX Devices” on page 13](#) for details).

Live Input Monitoring Through Helix Native Plug-in

Another great benefit of audio effects plug-ins is the ability to monitor your input signal through the plug-in inserted on the track. This allows you to dial in the desired tone, such as a customized set of amp, cab & effects within the instance of Helix Native, and then hear your guitar (or other track input signal) processed by it in real-time. Once you hit record, only your “dry” D.I. guitar signal is actually recorded into the track, which provides the huge benefit of being able to completely change the plug-in settings at any time, right up until you do a final mix-down of the DAW project!

Live Input Monitoring is a function of your host DAW application, and is typically accomplished by the following steps. Each host DAW is slightly different, so be sure to consult your DAW application’s documentation for details.

1. Configure your audio track’s input options to receive input from whatever physical input your guitar (or desired instrument) is plugged into.
2. Insert Helix Native on the track, as described in the previous section.
3. Set the track’s Record Arm button to “on” so that the track receives audio input.
4. Activate the track’s “Input Monitoring” feature. This is typically a button found near the Record Arm button. This feature allows the live track input to be fed through the DAW track and all plug-ins inserted on the track.

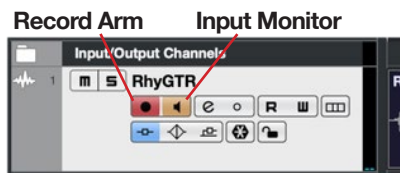

An audio track in Cubase configured with Record Arm & Input Monitoring active

NOTE: When utilizing your DAW track’s “Input Monitoring” feature, you’ll want to be sure to disable any “Direct Monitoring” signal on your audio interface (many interfaces offer an optional function that routes your input signal directly to its outputs, without going through the DAW software). This way you’ll hear **only** the input signal fed through the Helix Native plug-in. See your audio interface’s documentation for details.

5. Now when you strum your guitar, you should hear your signal through the track with the Helix Native processing applied. You can hit the Record button and try a pass at recording your performance. Upon playback you can then experiment with tweaking the Helix Native settings even further!

About Latency

Since this input signal is being fed round-trip—into your audio interface, through the DAW software and back out your audio interface’s outputs—it is subject to some amount of “latency.” Latency is the time between when you pluck a note on your guitar and hear the resulting audio output through your monitoring system. Latency is a function of your audio interface, host DAW software and the recording capabilities of your computer system. You can generally get the lowest latency by reducing your buffer size options for your audio interface driver within in your host DAW software’s Preferences. Please see your DAW software’s documentation for details.

Optimizing the Input Level

The level of the input signal entering the Helix Native plug-in can affect the overall gain and saturation of your tones, therefore, it is essential to “gain stage” accordingly. It is important to note that most Helix Native Amp & Effect models are designed to receive “Instrument” level input signals, much like plugging an electric guitar directly into the same type of amp or effects pedal we modeled them after. To follow are several tips for achieving the optimal signal level.

NOTE: Please also see [“Master Input & Output Level Controls” on page 34](#).

- For the most accurate results when recording “dry” electric guitar (or bass), we recommend that you use an audio interface with a “Hi-Z” or “Instrument” input.
- For monitoring your input signal level (or the playback level of any clips within your track), reference the **Master Input Level meter** within the plug-in.

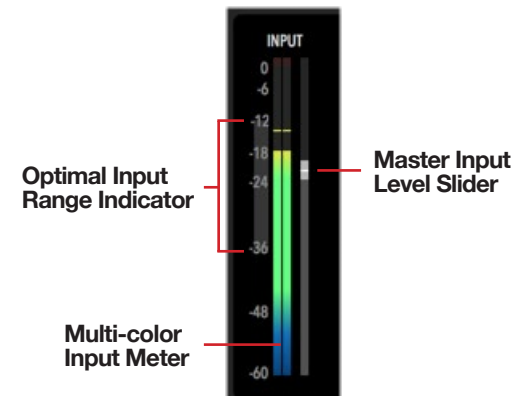

The Master Input Level controls

- The **Optimal Input Range Indicator** provides a guideline for where you should keep your input level, between -36 dB to -12 dB.
- The **Multi-color Input Meter** also provides guidance. Basically, strive for keeping your input level in the green and yellow, and avoid the blue (signal is too low) and red (signal is too high).

- If your audio interface offers input level adjustment, it is typically best to adjust it there to keep the recording level entering the plug-in within this optimal range. If needed, you can adjust the plug-in **Master Input Level Slider** to fine-tune the level. The Master Input and Output Level sliders are global per plug-in instance and, therefore, their values are not saved per preset.
- Guitars with active pickups may have a hotter output than traditional passive pickups. If your guitar utilizes active or especially high output pickups, set your audio interface or preamp's input "pad" to on, if available.
- Clipping, as indicated when the red **Clip Indicator** lights up, should **always be avoided** on both the plug-in's input and output meters.



The Input meter showing a clipped input level

GUI Overview

The Helix Native plug-in has a very simple, easy-to-use interface which functions as both a Librarian for your Helix Preset and Impulse Response files and as an Editor to create and customize your tones.

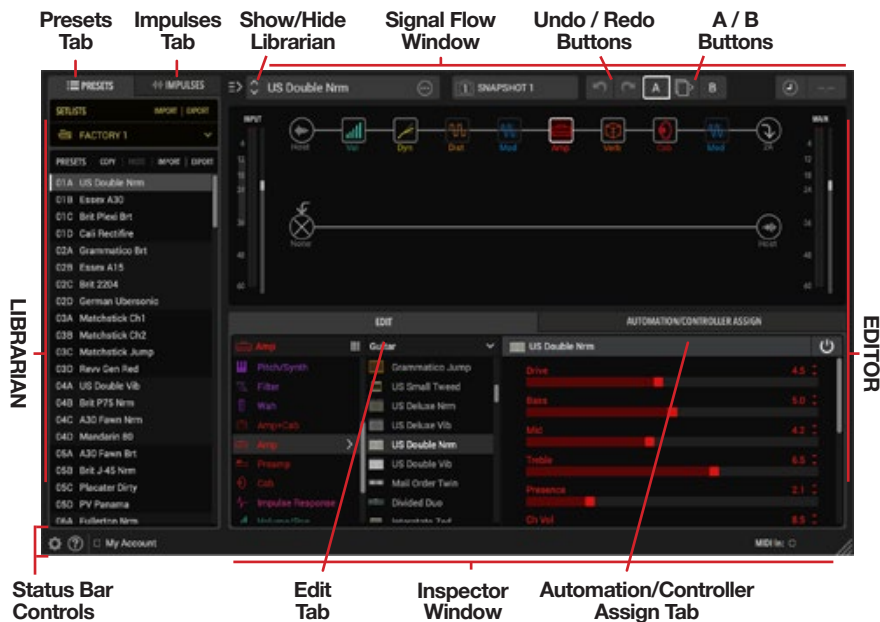

Navigation within the plug-in's user interface is divided into three main windows:

The Librarian Window - For managing presets and impulse response (IR) files—see [“Presets Panel” on page 20](#) and [“Impulses Panel” on page 24](#).

The Signal Flow Window - Where you can add and move amps & effects blocks, and customize your complete signal path routing—see [“The Signal Flow Window” on page 34](#).

The Inspector Window - Where you can choose from the huge selection of models, edit their parameters, and create and manage parameter automation control—see the Inspector Window chapters on [page 40](#) and [page 43](#).

Customizing the Helix Native Plug-in Window

Resize the Plug-in Window - The plug-in's window is resizable to allow you adjust the window size that best suits your screen and workflow. Simply click and drag using the “grab handle” at the bottom right of the plug-in window to reduce or increase the window size independently for any instance of the Helix Native.

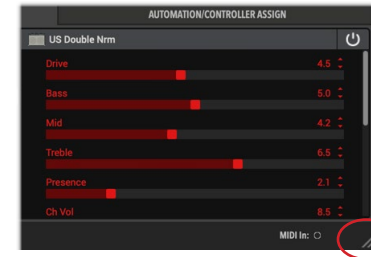

Drag the “grab handle” on the bottom right of the plug-in window for resizing

Show or Hide the Librarian Panel - It is also possible to show or hide the Presets/Impulses Librarian panel independently for each instance of the plug-in, by clicking on the toggle button at the top left of the Signal Flow window.

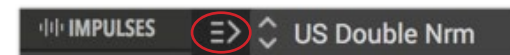

The Librarian Panel's Show/Hide Button

Undo / Redo

Helix Native supports Undo and Redo for most edit actions performed within the plug-in window, accessible via the Undo and Redo buttons at the top of the main plug-in window. The Undo / Redo history is tracked per instance of the plug-in. See [“Undo and Redo” on page 28](#).



The Undo and Redo buttons

A / B Compare

This set of buttons allows you to temporarily store all the Helix Native plug-in instance’s parameter settings, then tweak any number of parameters and easily compare the sound of your edited settings vs your original stored settings. See [“Using the A/B Compare” on page 29](#).



The A/B Compare controls

Status Bar Controls

This bottom row of the main plug-in window includes several options.

Plug-in Preferences, Help & Account Options

At the bottom left of the plug-in window, click on the menu buttons to access the plug-in Preferences, Help & About Box, (see [page 54](#)) and My Account options (see [page 59](#)).

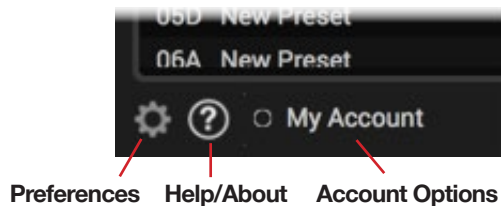

MIDI In Indicator

At the lower right of the main window, you’ll see a handy MIDI In indicator light. When Helix Native receives MIDI input, you’ll see this light up green—which can be a big help to let you know you have correctly routed your MIDI controller data into the plug-in for accessing its MIDI Control and bypass assignments (see [page 49](#)).



Preset Compatibility with Helix and HX Devices

Since the engine of Helix Native is essentially the same as the one utilized in all Line 6 Helix and HX products, we've made things even more flexible within Helix Native by offering **Hardware Compatibility modes** (HC modes), to emulate Helix and HX devices, as well as **Preset Translation**. As covered in the following sections, these features provide the ability to share presets between Helix Native and all Helix and HX devices, allowing you to greatly expand your library of Helix Native tones.

TIP: The HC mode can also be turned **Off**, which means you can construct a preset in Helix Native using as many blocks as will fit on its signal paths, regardless of block type (Amps, Cabs, IRs, and Effects) and DSP usage, effectively “unleashing” Helix Native from any per-instance DSP limits!

Loading vs. Importing Presets into Helix Native

Key to the Helix Native HC mode and preset translation functionality is for you to understand the difference between what we refer to as *loading* a preset vs. *importing* a preset, since options and behaviors differ for these actions. Please also refer to [“Presets Panel” on page 20](#).

Loading a Preset

In Helix Native, you **load** a preset to utilize it as your current tone, which is what you see within the plug-in's Signal Flow. You can load a preset in Helix Native in any of the following ways:

- Using the **Open From File** command from the Preset Menu button at the top of Signal Flow panel.
- Drag a preset from any computer folder, or from the HX Edit app's Preset Library list, and drop it directly into the Helix Native Signal Flow panel.
- Double-click on any preset in the Presets Library at the left to load it from the current library into the Signal Flow. (Note that any preset already within the Helix Native Presets Library was already translated upon import, so no further translation process is necessary.)

When you load a preset, Helix Native automatically detects the device (or HC mode) from which it was created and, if the preset differs, Helix Native offers you the option of either switching the plug-in's HC mode to match the preset's originating device, or to attempt to translate the preset to match the plug-in's current HC mode (see [“Changing HC Mode on Preset Load” on page 16](#) for details).

Importing a Preset

In Helix Native, you **import** a preset to add the preset to the plug-in's Presets Library. You can import a preset into Helix Native using any of the following methods:

- Select a slot within the plug-in's Presets list and click the **Import** button just above the list.
- Drag a preset from any computer folder, or from the HX Edit app's Preset Library list, and drop it directly into a slot within the Helix Native preset list.
- **Copy** a preset from the HX Edit app's Preset Library list, and **Paste** it directly into a slot within the Helix Native preset list.
- Use the **Setlist Import** button at the top of the Presets Panel, or **Import Bundle** (Helix and Off HC modes only for bundle file support) button in the plug-in's Preferences window to import a setlist or bundle from your computer. All presets therein are attempted to be imported (following the same rules as described in [“Preset Translation” on page 15](#)). This import action changes the Helix Native HC mode to match that of the imported setlist/bundle file, and any presets within the setlist or bundle that are not translatable are not imported.

When importing a preset, Helix Native will automatically attempt to convert it to match the current Helix Native HC mode. If it cannot be translated, you'll get a dialog alerting you why. In this situation, the import is aborted and the current HC mode is left unchanged.



Alert dialog when attempting to import a preset that cannot be translated

Once imported, the preset is retained within this HC mode's individual Presets Library.

Hardware Compatibility Modes

The current HC mode within Helix Native is indicated, and can be manually changed, by the **Current Hardware Compatibility Mode menu**, found in the Preferences window - Hardware Compatibility tab (see [page 55](#)). Helix Native will also prompt you to adopt the matching HC mode when loading a preset, as covered in the following sections.

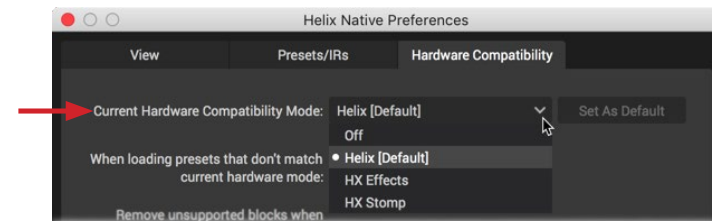

The Current Hardware Compatibility Mode menu

NOTE: The HC mode can also be changed automatically by loading a preset that was created with a different HC mode (or device type) than is currently in use in Helix Native. Please see [“Changing HC Mode on Preset Load” on page 16](#).

When you select one of the HC modes from the menu, the UI and functionality of the current Helix Native plug-in instance change to match those of the selected device (as well as matching the UI of the HX Edit application when connected to the selected device type). This includes the Signal Flow, maximum block per path capacity, Model menu and model type options, and includes its own independent Preset Library and set of Factory Presets. The menu options and respective Helix Native Hardware Compatibility modes are as follows. Also see the [“HC Mode Feature Comparison Table” on page 15](#) for differences between these modes.

Helix Mode - Presets exported from any Helix device (Helix Floor, Helix LT, or Helix Rack) can be loaded or imported into Helix Native in this mode (or back into HX Edit with a Helix Floor/LT/Rack device connected), with no translation required. (If you’re familiar with any earlier version of Helix Native, this Helix mode is essentially the same.)

HX Effects Mode - Presets exported from an HX Effects device can be loaded or imported into Helix Native in this mode (or back into HX Edit with an HX Effects device connected), with no translation required.

HX Stomp Mode - Presets exported from an HX Stomp device can be loaded or imported into Helix Native in this mode (or back into HX Edit with an HX Stomp device connected), with no translation required.

Off - Once a preset is saved in, or exported from, Helix Native in this HC mode setting, the preset can be loaded or imported into Helix Native in this mode setting with no translation required. When set to Off, the UI and options are essentially the same as the Helix HC mode, but with several restrictions removed (see the [“HC Mode Feature Comparison Table”](#)).

Just remember when working in this Off mode—with greater power comes greater responsibility! Without the restrictions imposed as in other HC modes, it is possible to create a preset in a single plug-in instance that can place significant CPU demands on your computer system. Also, creating a preset that exceeds the limits of other HC modes also means the preset will not be able to be translated and utilized in HX Edit with *any* Helix or HX device, and only loaded in Helix Native when it is set to the HC mode Off state.

Set As Default Button

Changing the HC mode in one instance of the plug-in does not affect the HC mode in use by any other existing Helix Native plug-in instance. Future, new instances of Helix Native will utilize the designated Default HC mode. Click the Set As Default button to configure the currently selected HC mode as the Default, globally for all future plug-in instances. Initially, the Helix mode is set as the Default.

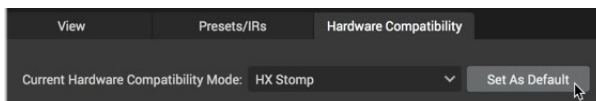

The HC mode - Set As Default button

Changing to a Different HC Mode

Once you select a different mode from the HC Mode menu, Helix Native will first automatically alert you that are about to make a HC mode change. Choose **OK** to proceed, or, if this tone is one you want to save in its original HC mode format, choose **No**, and then Save or Export the tone as a preset before changing to the new HC mode.

If you click **OK** to proceed, Helix Native will attempt to translate your currently-loaded tone into the HC mode format you selected. If translation is possible, your (translated) tone remains the current tone within the plug-in’s Signal Flow (see the following sections for more about preset translation). Note that the now translated, current tone is in an un-saved state, so you’ll want to use the preset menu’s **Save To Library** command if you want to retain it within the Presets Library for this HC mode.

If your currently-loaded tone is not able to be translated to your new selected HC mode, you’ll see an alert, asking if you want to proceed with the HC mode, discarding the preset.

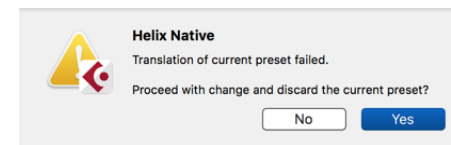

Preset translation alert—changing from Helix to HX Stomp HC mode

Choosing **Yes** will discard your current tone (meaning, the un-saved tone will be lost) and change to the select HC mode, loading an “empty” Signal Flow for your current tone. Choosing **No** will abort, leaving your current tone and HC mode unchanged.

Note that whenever you save or export a tone from Helix Native, it is saved as a preset in the current HC mode/hardware format. A Helix Native preset may be able to be translated and imported or loaded into Helix Native while in a different HX mode. Likewise, the preset may be able to be translated and imported or loaded into HX Edit with a different device type connected. The ability for the preset to be translated depends upon destination mode/device’s block count, DSP, and path limits—see the following [“Preset Translation”](#) section for details.

NOTE: Some DAW host applications (such as Cubase and Pro Tools) include their own plug-in preset functionality, independent of the Helix Native Preset Library. Since changing the HC mode within the Helix Native results in the plug-in instance utilizing the specific Preset Library of that mode, you could get unexpected results if attempting to use your DAW host application’s own plug-in preset features. Therefore, we recommend you use the Helix Native built-in Preset Library to save, load and manage all its presets.

HC Mode Feature Comparison Table

The following table shows the primary differences between the four selectable Hardware Compatibility modes in Helix Native. You can consult this table to determine if a preset created in one HC mode (or device type) will be able to be translated to other HC modes. Also see the **Preset Translation Compatibility** table in the next section for more info.

HC MODE / DEVICE FEATURE COMPARISON				
Feature	HC Mode or Device Type:			
	Off	Helix	HX Stomp	HX Effects
Included Models*	Full set of v2.90 Helix models	Full set of v2.90 Helix models	Full set of v2.90 Helix models, except 6 Switch Looper	Full set of v2.90 Helix models, except Amps & Cabs
Blocks Per Path Capacity	16	16	6	9
Max. Block Type Per Path	None	2 Amps, 2 Cabs, 2 IRs (1,024 sample) or 1 IR (2,048 sample)	2 Amps, 2 Cabs, 2 IRs (1,024 sample) or 1 IR (2,048 sample)	2 Amps, 2 Cabs, 2 IRs (1,024 sample) or 1 IR (2,048 sample)
Max. DSP Limit	None	Same as Helix	Same as HX Stomp hardware	Same as HX Effects hardware
Snapshots Per Preset	8	8	3	4
Preset Library (independent per HC mode)	8 Setlists for up to 1,024 Presets. Bundle support included	8 Setlists for up to 1,024 Presets. Bundle support included	1 Setlist for up to 128 Presets	1 Setlist for up to 128 Presets
Impulses Library (shared between HC modes)	Holds up to 128 User IRs	Holds up to 128 User IRs	Holds up to 128 User IRs	Holds up to 128 User IRs

*Also see [“Model Lists” on page 61](#) for the categories and lists of included models.

Preset Translation

As covered in the preceding sections of this chapter, when **loading** or **importing** a preset, Helix Native will automatically attempt to “translate” the preset to match the plug-in instance’s current Helix Native HC mode. If it cannot be translated, you’ll get an error window letting you know the preset is not compatible with the current HC mode.

 **TIP:** This preset translation functionality is also available within the HX Edit application. Whenever loading or importing a preset into HX Edit—whether exported from Helix Native in any HC mode, or from any Helix or HX type device—HX Edit will always automatically attempt to translate the preset for the currently connected device. Please see the [HX Edit Pilot’s Guide](#) for details.

Presets cannot be translated if created with a device or mode that includes features or capabilities that exceed those of the current HC mode (see the preceding **Feature Comparison** table). The following table further illustrates the translation conditions, and the following sections in this chapter go into further details on compatibility of individual preset features.

 **NOTE:** Likewise, if importing multiple presets, a setlist, or a bundle, where one or more presets are not able to be translated to the current HC mode, the non-translatable presets display an error window and are not imported, while the eligible presets are successfully translated and imported.

Preset Translation Compatibility Table

The following table provides an overview of the preset translation capabilities from each source device (or each source Helix Native HC mode).

PRESET TRANSLATION COMPATIBILITY				
Created With:	Can Be Translated To:			
	Off	Helix	HX Stomp	HX Effects
Helix Native HC mode = Off	✓	If does not exceed Helix block count and DSP limits	If does not exceed HX Stomp Block and Path count and DSP limits	If does not exceed HX Effects Block and Path count and DSP limits
Helix (Rack, Floor, LT) or Helix Native HC mode = Helix	✓	✓	If does not exceed HX Stomp Block and Path count and DSP limits	If does not exceed HX Effects Block and Path count and DSP limits
HX Stomp or Helix Native HC mode = HX Stomp	✓	✓	✓	If does not exceed HX Effects Block and Path count and DSP limits
HX Effects or Helix Native HC mode = HX Effects	✓	✓	✓	✓

Controller Support

Note that Helix, HX Stomp, and HX Effects modes/devices each have their own set of supported types and numbers of controllers (number of Snapshots, EXP Pedal controllers, Command Center options, etc.) When translating a preset to a Helix Native HC mode that has lesser support of these controller features, the non-supported controllers are discarded from the translated preset.

Changing HC Mode on Preset Load

When you **load** any .hlx preset file, such as by dragging a preset file from another computer window and dropping it directly into the plug-in's Signal Flow, Helix Native automatically detects the device type or HC mode with which the preset was created and prompts you with the option to change HC mode, or to attempt to translate the preset to load it within the current HC mode.

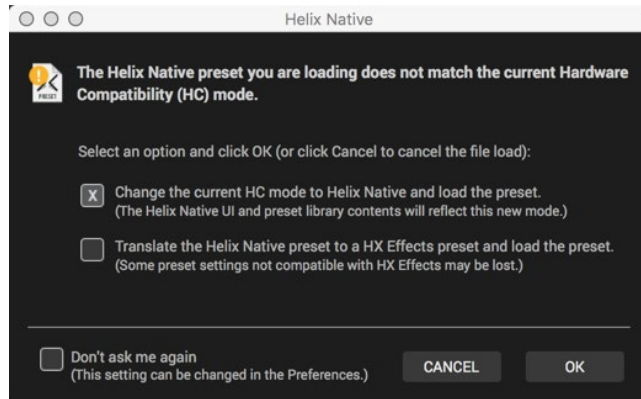

Change HC mode prompt window

The options in the prompt window are as follows.

Change the current HC mode - Helix Native changes its HC mode to match that of the preset you are loading, and then loads it as the current tone.

Translate the preset - Helix Native attempts to translate the preset to that of the current HC mode and, if able to translate it, loads the preset. If the preset cannot be translated to the current HC mode, the preset is not loaded and no change is applied to the plug-in's HC mode state.

Don't ask me again - Selecting this option will stop the Change HC Mode prompt window from appearing, and automatically apply the above option that is selected for all future preset load actions. (You can change this behavior within the Preferences > Hardware Compatibility tab window at any time.)

Preset Compatibility with Helix and HX Devices

As covered in the preceding sections, as of Helix Native v1.80 and HX Edit v2.80, the preset translation functionality and Helix Native Hardware Compatibility modes make it possible for **any** presets from Helix and HX devices to be exported from HX Edit and utilized within Helix Native. Likewise, you can also utilize Helix Native to create presets that will be fully compatible with whatever Helix or HX device you want to use them on. This compatibility is the foundation of the Line 6 “Studio to Stage” concept!

TIP: If you own a *Helix* or *HX* device, be sure to check the “Helix compatible” version number (found in the Helix Native Preferences' About box—see [page 56](#)) to determine the recommended Helix firmware version you should use for preset compatibility. For optimal compatibility with Helix Native v1.90 and HX Edit 2.90, you'll also need to be running the v2.90 device firmware (or later)—the best practice is really to just always use the latest versions of all Line 6 software, device drivers, and firmware!

Presets, setlists and bundles can simply be imported into the Helix Native or the HX Edit app using their Import functions, as covered in the following sections. It is also possible to drag and drop presets directly between the applications' Preset panels. Once imported into the HX Edit application, presets are immediately loaded onto your connected Helix device, replacing the presets within the device's internal memory. When importing presets into the Helix Native Presets Library, they are then available for any instance of the plug-in that is set to the same HC mode.

NOTE: As with all plug-ins, the specific settings you last used within your existing plug-in instances are retained as part of your host DAW project and not affected unless you manually load a different preset into the plug-in's Signal Flow. Instances of the Helix Native plug-in that already exist in previous host DAW projects will also reference the current plug-in Presets Library lists when you load the DAW project again.

Since the different Helix device types include different physical inputs and outputs, some variances exist among settings, as well as for their support of block types & controllers, which may affect the sharing of presets between HX Edit and Helix Native plug-in. These differences are detailed in the following sections.

HX Edit Application

Line 6 *HX Edit* is the editor/librarian software for use with Helix hardware devices that are running firmware version 2.20 or later. For best performance, it is recommended to use the latest version of both the HX Edit application and Helix firmware. If you own a Helix that is still running a firmware earlier than v2.20, you'll need to update the Helix device's firmware to the v2.20 firmware or later, or use the previous *Helix* application with your Helix device.

For optimal preset compatibility between Helix Native plug-in and Helix/HX hardware, you should always be sure to use matching versions of the Helix Native, device firmware, and the HX Edit (or Helix) application. The easiest (and recommended) way to be sure your presets are compatible is to update to all the latest versions available for Helix Native, firmware and HX Edit. All Line 6 software is available for download from line6.com/software.

Helix Native and Helix/HX devices each include some differences in preset capabilities, due to different inputs, outputs, switch and controller support, etc. The following sections cover the details of what you can expect when sharing presets between Helix Native and Helix and/or HX devices.

HX Edit Preset Translation

Just as described in the preceding sections for Preset Translation functionality in Helix Native, HX Edit offers the same capabilities whenever importing or loading a preset. Regardless of the specific Helix or HX device type currently in use with HX Edit, the application will automatically identify the device or Helix Native HC mode type from which the preset was created, and attempt to translate the preset to match the current device's format.* Please also see the [HX Edit Pilot's Guide](#).

***TIP:** Note that some preset functions may be disabled and/or removed accordingly to make the preset compatible with the destination device in HX Edit. Therefore, it is a good idea to retain a backup of your original presets, and save new, individual versions of “translated” presets after importing them into a different device format!

HX Edit Backup Files

The HX Edit application includes a feature that creates Helix Backup (.hxb) files that can be utilized to restore a Helix or HX device's presets, IRs and global settings. Helix Native does not currently include this feature and, therefore, does not support creating or opening Helix Backup files.

Block Copy and Paste

Using the Copy and Paste Block commands, you can copy/paste any individual block between presets within any instance of Helix Native, as well as between Helix Native and HX Edit with any Helix or HX type device connected. It is also possible to **drag and drop** any processing block to move it within the current preset, or to copy it into any other Helix Native plug-in or HX Edit device window. Restrictions apply when copying and pasting some block types, depending on the HC mode in use within Helix Native, on the Helix hardware in use, and the paste destination—please see [“Cutting, Copying & Pasting Blocks” on page 35](#).

Marketplace Assets

All premium presets and IRs purchased from the online Line 6 Marketplace that are offered for Helix and HX devices are compatible with Helix Native plug-in (license authorization and version Helix Native 1.70 and later are required). Please see [“Marketplace & Account Options” on page 58](#).

Input & Output Block Settings

When Importing a Helix or HX Hardware-exported Preset into Helix Native - All Input and Output blocks currently set to physical Inputs and Outputs (other than “None”) will default to the “Host” setting within the plug-in.

When Importing a Helix Native-exported Preset into Helix or HX Hardware - All Input and Output blocks currently set to “Host” will default to the “Multi” setting within the Helix hardware. Any Input block set to “None” will remain as set to “None” within the hardware.

Hardware Blocks (Send, Return, FX Loop & Looper)

When Importing a Helix Hardware-exported Preset into Helix Native - These hardware block types are only functional within Helix/HX devices and, therefore, their parameters are not editable. These blocks have no routing functionality within Helix Native.

***NOTE:** If an existing Send, Return or FX Loop block is toggled as “active” via its Bypass switch, it can reduce or fully mute the path's audio signal, depending on the block's **Mix** or **Dry Thru** parameter settings. To ensure these block types are not affecting the plug-in's signal path, simply toggle the block to bypassed.

If you load a preset that happens to include any of these types of hardware blocks, you'll see them appear within the Signal Flow with an indicator to remind you they are non-functional within the plug-in.*



An FX Loop, Send, Return, and Looper block within a Helix hardware-exported preset

***NOTE:** Within the Preferences - Hardware Compatibility tab window, you can enable the option for Helix Native to automatically **“Remove all non-functional hardware blocks”** from presets whenever importing Helix presets, setlists or bundles (see [page 56](#)). However, regardless of this Preference setting, it is still possible to Paste one of these unsupported blocks into Helix Native from the HX Edit app, if it remains as the most recently copied item in your clipboard.

When you select one of these hardware blocks within the Signal Flow, you'll see a reminder within the Edit tab to alert you it is non-functional, and see that its parameters are not editable (dimmed). However, these blocks and their original settings remain fully functional if and when the preset is exported from Helix Native and imported back into HX Edit.



An “unsupported” block's parameters within the Helix Native Edit tab

***NOTE:** Note that it is not possible to add non-functional hardware blocks to your tone from the Helix Native model menu—the Send/Return and Looper menu categories of the Edit tab's Model Browser remain non-selectable.

Impulse Responses

Impulse Response (IR) files are able to be utilized within IR blocks of Helix Native just as they are within Helix and HX devices. You can simply import IRs using the Helix Native Impulses panel to build your Library of IRs that are available to Helix Native. Helix hardware retains its own separate IR Library (managed by using the HX Edit application).

If you are to be sharing presets between Helix Native and Helix or HX devices, it is a good idea to build and maintain your IR Libraries similarly on each to allow the same IR files to be utilized for your presets that include them. Please see [“Impulses Panel” on page 24](#) for details.

NOTE: The Impulses Library within Helix Native is shared between all HC modes. Also see [“Hardware Compatibility Modes” on page 13](#).

Hardware Controller Assignments

Helix and HX devices, as well as the HX Edit editor application, offer the ability to create several types of “controller assignments” to provide remote control of preset parameters via Helix/HX footswitches, expression pedals and external MIDI gear. These controller assignments are saved and retained within Helix/HX hardware-exported presets. By default, hardware assignments are not visible when a preset is loaded in Helix Native, but they can optionally be set to be displayed in the Helix Native Edit tab and Assignment List—see [“Hardware Controller Assignments within Helix Native” on page 43](#).

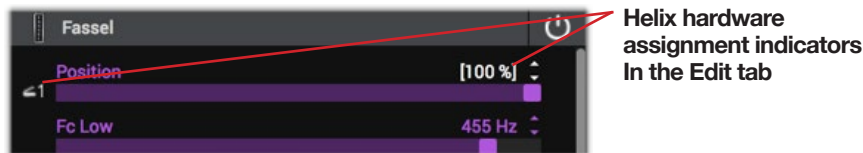

Indicators on an Edit tab slider that a parameter includes a controller assignment

Helix hardware controller assignments offer no functionality within Helix Native plug-in, and any parameter itself that includes an assignment remains adjustable and functional within Helix Native. MIDI controller assignments created within HX Edit **are** supported and functional within Helix Native. These controller assignments also continue to be retained in the preset, even once exported from Helix Native, allowing them to still function if imported back into a Helix or HX device again. Please see the Helix and HX [Owner's Manuals](#).

TIP: Note that, within Helix Native, you can utilize your host DAW application parameter automation functionality to control the bypass of blocks and parameter values in real-time! Please see [page 43](#).

NOTE: HX Stomp and HX Effects devices, and therefore, the HX type HC modes in Helix Native, support fewer hardware controller assignment types than Helix devices and modes.. Also see [“Hardware Compatibility Modes” on page 13](#).

Snapshots & Snapshot Assignments

Snapshots & snapshot assignments created and saved within a Helix or HX device's preset are compatible when the preset is loaded in the Helix Native plug-in, and vice-versa. However, there are a few specific functions that can exist within Helix hardware-created presets that Helix Native does not support, as described below.

- Helix hardware Command Center message data (see previous section).
- Line 6 Variax instrument tunings and other Variax parameter settings.

These types of data within snapshots are essentially ignored by Helix Native, with all other supported snapshot settings recalled just as on Helix hardware. Both supported and non-supported snapshot data are retained within your Helix Native-exported presets when loaded on Helix hardware again. Please also see [“Working with Snapshots” on page 31](#).

NOTE: The current snapshot, along with all its settings, can be copied and pasted using the **Copy Snapshot** and **Paste Snapshot** commands either within the current Helix Native preset or within the current HX Edit preset, but not between the Helix Native plug-in HX Edit app, and not between HC modes within Helix Native. Also see [“Copying, Pasting & Renaming Snapshots” on page 33](#).

Also keep in mind that, when loading a Helix or Helix Native-created preset while Helix Native is currently in an HX device HC mode, HX modes support fewer snapshots (HX Effects presets include up to 4 and HX Stomp up to 3 snapshots, where Helix/Helix Native presets support up to 8 snapshots). Therefore, when a preset is translated to one of the HX device HC modes, the extra, non-supported snapshots and their contents are discarded.

Bypass Assignments

A common practice within Helix devices is to configure “bypass assignments” where the bypass parameter of blocks are then toggled Off/On via the device's footswitches, or optionally by expression pedals or external MIDI commands. Currently, MIDI bypass assignments are supported in Helix Native (see next section), but not other types of bypass assignments that can be created within Helix hardware. If you happen to change the bypass state of block that includes a Helix hardware bypass assignment and export the preset, you will overwrite the saved state of the assignment when the preset is imported back into a Helix device.

Also note that when a preset is loaded while Helix Native is currently in a different HC mode from which the preset was created, bypass assignments that exist for footswitches and controllers that don't exist within the device HC mode are discarded when the preset is translated.

Controller Assignments

Helix device users can create “controller assignments” to map the control of parameters (such as a wah or volume, a delay's Mix parameter, etc.) to a Helix expression pedal, footswitch, or external MIDI controller device. Currently, MIDI In controller assignments are supported in Helix Native plug-in (see next section), but not other types of controller assignments that can be created within Helix hardware.* If you edit a parameter that includes a Helix hardware controller assignment, and then export the preset from Helix Native, your last-used parameter value is the same value the parameter will default to upon import within a Helix device.

 ***NOTE:** When importing a preset into Helix Native which includes HX Edit-saved hardware controller assignments, you'll see the assigned parameter sliders within Helix Native display their values in white brackets indicating the assignments. Even though these hardware controller assignments are not supported within Helix Native, they are preserved with the preset (as well as with the respective, individual blocks for copy/paste). Therefore, these assignments will still be intact if you import the preset back into HX Edit.

MIDI In Bypass & Controller Assignments

Helix device users can create MIDI In bypass assignments to remotely toggle the bypass of most block types, and create MIDI In controller assignments to remotely control most Helix parameters, via external MIDI controller devices or MIDI software. These MIDI In assignments are also supported by Helix Native. Likewise, MIDI In bypass and controller assignments created in Helix Native presets are also supported when the preset is imported into Helix devices via the HX Edit application. See [page 49](#).

Command Center Assignments

The Command Center in Helix devices provides the ability to assign the transmission of MIDI/QWERTY Hotkey/CV/Amp switching and other commands to Helix hardware switches and expression pedals. Helix Native does not support the transmission of these types of commands and, therefore, essentially just ignores any Command Center assignments that may exist within an imported Helix preset. Existing Command Center data is retained when exporting a preset from Helix Native.

Automation Controller Assignments

Since parameter automation is a functionality specific to DAW hosts and software plug-ins, all automation controller assignments saved within a Helix Native-exported preset will be ignored when the preset is loaded on Helix hardware devices. However, these assignments are retained if and when the preset is exported from a Helix device. See [“Controller Assignment for Automation” on page 44](#).

Customized Hardware Footswitch Labels and LED Colors

Helix and HX Effects devices include the ability to customize the labels displayed on their “scribble strips” (on Helix Floor, Helix Control, and HX Effects devices) and on-screen footswitch labels (on Helix LT devices), as well as to customize the color displayed for their footswitch LED rings. This data is stored within a hardware-exported preset, but is not utilized by the plug-in, nor altered when importing or exporting the preset with Helix Native.

 **TIP:** Remember, you can create an unlimited collection of backups of your presets, setlists and bundles from both Helix Native plug-in and the HX Edit application using their Export functions. It is good advice to follow the golden rule, “back up early and often” so that you always have copies of your favorite Helix tones!

Computer Processing Management

As covered at the start of this chapter, in order to maintain preset compatibility with Helix and HX devices, each HC mode within Helix Native (except for the “Off” mode option) incorporates a similar processing management as the DSP management system utilized on the hardware device type. That is, Path 1 (and Path 2, if in a Helix or Helix Native HC mode) within an instance of the plug-in each have a maximum computer processing limit. Once this limit is approached on either path, the Edit tab's Model Browser options become dimmed if the specific models require an amount of processing power that would surpass maximum limit for the target device type/HC mode. (Please see [“Availability of Models within the Model Browser” on page 40](#).) This way, any preset created and exported from the Helix Native is ensured to be able to be imported and utilized in HX Edit for the intended target device.

If you set the Helix Native HC mode to “Off,” the processing limits are completely removed, allowing you to add up to the maximum number of any blocks (and block types) that will fit on any path. Note that this makes it possible to create an extreme CPU demand in just one instance of the Helix Native plug-in, so it is best to be careful not to bog down your DAW system with unnecessarily power-hungry plug-in options!

 **TIP:** Please also see [“Tips to Optimize Processing Power Usage” on page 39](#).

Presets Panel

The Librarian's **Presets Panel** provides functionality for loading, importing & exporting Helix presets & setlists to manage the plug-in's Presets Libraries. Helix Native incorporates one Preset Library for each of its four selectable Hardware Compatibility modes (or HC modes), each with its own set of Factory Presets (please see [“Hardware Compatibility Modes” on page 13](#)). When you select a HC mode, the respective library for the mode is automatically loaded, allowing you to build and manage your presets separately for each.

NOTE: As covered in the preceding chapter, when you import a preset into the Helix Native Presets tab, if the preset was created using a different source device or HC mode than the HC mode currently in use by the plug-in, Helix Native will attempt to translate it. If translated, the preset is successfully imported and then resides within the current mode's library.

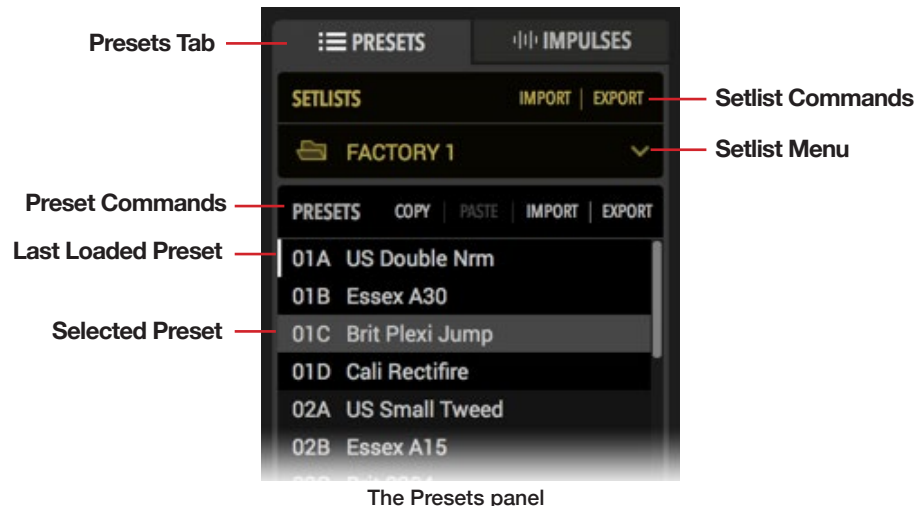

The Presets panel

Presets Tab - Click on this tab to display and place focus on the Presets panel.

Preset Commands - Click on any command in this row to perform its action on the currently selected Preset(s).

Last Loaded Preset - When you double-click on any preset in the panel, it loads it into the Signal Flow as the current tone in use by the plug-in. The white vertical line at the left of the preset slot indicates that this is the last preset from within your presets library that was loaded.

NOTE: It is important to note that, once a preset is loaded as the current tone, changes to the current tone does not affect the preset within the Presets Library panel unless you specifically Save the tone to the Preset Library—see [“Using the Preset File Menu” on page 28](#).

Selected Preset - Click once on any preset in the panel to select it, and you'll see it appear highlighted, as shown above. The selected preset is the one that is acted upon when choosing any Preset Command. Note that when you load a preset, it remains the selected preset until you click on any other preset within the panel. It is also possible to select multiple presets to perform actions on them simultaneously, as covered in the following sections.

Setlist Commands - Click on any command in this row to perform the selected action on the current Setlist.

Setlist Menu (Helix and Off HC modes only) - Click here to display one of the 8 Setlists of the Presets Library. Right-click directly on the current Setlist's name here to rename it.

NOTE: When in the Helix or Off HC mode, it is also possible to import and export all setlists, including all your presets and their last-saved settings by using the Bundle options found in the Preferences window. Please see [“Preferences - Presets/IRs Tab” on page 54](#).

Helix Native Factory Presets

The very first time you insert an instance of the Helix Native plug-in after installation, as well as the first time you select one of the four Hardware Compatibility modes (see [page 13](#)) you'll see a pop-up notice informing you that the mode's unique Preset Library and set of **Factory Presets** will be automatically imported. This automatically builds and populates the Helix Native HC mode with numerous Factory Presets to provide an easy start for your own sonic creations! The Helix and Off modes include 3 setlists of factory presets, and the HX Effects and HX Stomp modes include a large number of factory presets within their single setlists.

All factory presets can be edited and overwritten as desired. Most factory presets are intended for guitar, but, depending on the current HC mode, you'll also see presets titled starting with identifying codes, as follows.

- “BAS” presets are intended for bass guitar
- “FX” presets include FX blocks only (no amp or cab blocks)
- “DIR” presets are intended for direct guitar recording and include amps and effects blocks
- “VOX” presets are intended for vocals
- “KEY” presets are intended for keyboards
- “AUX” presets are intended for use on your DAW project's Auxiliary or Bus tracks

- You may also see some descriptively titled template presets, designed to provide an easy start for specific configurations, such as for “Parallel” effects processing, “Discrete Stereo” for 2 discrete channel processing, “Remote” for those that include QWERTY key commands to remotely control popular apps, etc. Also see [“The Signal Flow Window” on page 34](#) for more on Helix Native’s capabilities for mono, stereo, serial and parallel signal routing

TIP: If you want a clean start, we’ve also provided the options **Clear Preset Library** (to clear out all presets from all your plug-in’s current Library) and **Restore Factory Setlists** (to restore the original Helix Native factory presets). These commands act only upon the current HC mode’s Preset Library. Please see [“Preferences - Presets/IRs Tab” on page 54](#).

Premium Marketplace Presets

If you’ve purchased and downloaded premium presets from the Marketplace online shop, you must initially have Helix Native signed in, and your computer authorized, to allow the import or export of these presets (as well as for import and export of any setlists or bundles that include premium presets).*

NOTE: The authorization required for your Helix Native license also covers the use of any Marketplace premium assets on this computer—both within Helix Native (version 1.70, or later) and the Line 6 HX Edit (version 2.70, or later) application. Please see [“Authorizing your Computer” on page 5](#).

Premium Marketplace presets are otherwise able to be utilized just like any other Helix Native, Helix or HX device presets. When imported, these premium Marketplace presets are indicated by a golden guitar pick “badge” to their right within the Presets panel. Please also see [“Marketplace & Account Options” on page 58](#).

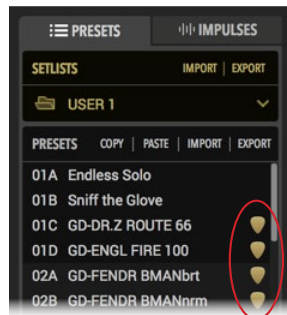

Premium Marketplace presets are indicated with a golden guitar pick badge

Loading Presets

Double-click on the desired preset from the Presets panel list to **load** it into the Signal Flow window as the current tone, with all blocks’ parameters accessible within the Edit tab. You can also use the **Next/Previous** preset buttons at the top of the Signal Flow window (see [“Navigating with the Next/Previous Preset Buttons” on page 27](#)).

NOTE: It is important to understand the differences and behaviors for **Loading** a preset into the Signal Flow and **Importing** a preset into the plug-in’s Preset Library. Please see [“Loading vs. Importing Presets into Helix Native” on page 13](#).

Alternatively, if you wish to load a preset that exists as a saved Helix preset (.hlx) file on your computer, you can do one of the following:

- Use the preset **Import** command button and select the desired preset from your computer to import it into the plug-in’s current Preset Library, then double-click the imported preset within the Presets list to load it as the current tone.
- Use the **Open from Disk** option from the menu at the top of the Signal Flow window. This **loads** the preset directly into the plug-in’s Signal Flow as the current tone (without importing it into the Preset Library).

NOTE: Use the **Save To Disk** or **Save To Library** command within the file menu at the top of the Signal Flow if you wish to retain any changes you’ve made to the current tone to create it as a preset that can be utilized by other Helix Native instances, as well as with HX Edit.

The Default Preset

Whatever preset resides within location 01A of the first Setlist becomes the designated **Default Preset** for the current HC mode’s Preset Library within Helix Native. You’ll see that this preset is the one automatically loaded into the Signal Flow every time you create a new instance of the plug-in (using the same HC mode). This allows you to set any preset you like as the Default Preset for Helix Native—by simply importing or saving it to this Preset Library location!

All settings that you customize and save to this library Default Preset are recalled when loaded, including automation assignments, routing configuration, block bypass states, etc.

Importing and Exporting Helix Preset Files

Helix presets are able to be exported from the Presets Library to be copied and saved to your computer as individual (.hlx) files, allowing you to create a limitless collection of tones that can be imported back into your Presets Library at any time.



To Import a Helix Preset File - Helix Native can import a Helix (.hlx) preset file that was created with Helix Native while in any Hardware Compatibility mode, or that was exported from any Helix or HX device (via the HX Edit application). Helix Native. To import a preset, click once to select the desired preset location within the Presets panel and click the **Import** preset command.

If Helix Native is already using the HC mode that matches the mode or device from which the preset was created, the preset is imported into the current Preset Library. If Helix Native is currently using a different HC mode, then you will be prompted to either change Helix Native to the matching HC mode, or have the plug-in attempt to convert the preset to the current HC mode. (Please see [“Hardware Compatibility Modes” on page 13](#) for details.) The imported preset will then remain available within the current HC mode’s Presets Library—and accessible for all instances of the plug-in that utilize this HC mode.

 **NOTE:** Importing a preset into the Preset Library does not also automatically load the preset into the Signal Flow of the plug-in. If you wish to load the imported preset as the current tone, double-click on the preset within the library location. Please also see ["Loading vs. Importing Presets into Helix Native" on page 13.](#)

To Export a Helix Preset - Click once to select the desired preset within the Presets panel, then click the preset **Export** command. This creates a copy of the preset from the Helix Native plug-in's Presets Library and saves it to your computer as a Helix preset (.hlx) file. The familiar Mac or Windows computer's **Save As** window is presented, in which you can edit the filename and choose a destination folder.

The exported preset file is saved in the device/mode format matching the current Helix Native HC mode.

 **TIP:** Using the Preset panel's **Export** command makes a copy of the selected library preset in its last-saved state and saves it to your hard drive. If you wish to save the tone currently in use within the plug-in's Signal Flow, with all edited settings intact, use the File menu - Save options (see ["Using the Preset File Menu" on page 28.](#))

Renaming, Reordering, Copying and Pasting Presets

These functions allow you to customize your presets within the current Preset Library panel. Choose **Rename**, **Copy** or **Paste** from the row of Preset command buttons and it will act upon the selected (highlighted) preset location. Or, optionally right-click on an individual preset location within the panel to open a context menu with these same commands. For most commands, it is also possible to multi-select a number of presets by using Shift+click to select a contiguous set of presets, or Cmd+click (Mac) or Ctrl+click (Windows) to select a non-contiguous set.

 **NOTE:** Copy and Paste of presets and IRs between Helix Native and HX Edit is not currently supported. However, you can use drag and drop for these actions! See the next section.

Drag and Drop Presets

Drag and drop any preset (or multi-selected presets) directly to or from the plug-in's Presets panel to perform the following actions.

- **Export** - Drag any preset from the plug-in's Presets panel into any folder on your computer to export a copy of the .hlx Helix preset file and save it there.
- **Import** - Drag any saved .hlx Helix preset file from your computer's hard drive and drop it directly into a slot within the plug-in's Presets panel to import it into the Presets Library. (Note that this does not automatically load the preset as the current tone in the plug-in. Double-click the preset slot you imported into to load the preset.)

- **Load** - Drag any saved .hlx Helix preset file from your computer's hard drive and drop it within the plug-in's Signal Flow window to load it.

 **NOTE:** This "Load" action loads the preset as the one used within this instance of the plug-in, but it does not import the preset into the plug-in's Presets Library. Optionally, you can add this loaded preset by using the File > Save to Library option within the Signal Flow window—see ["Using the Preset File Menu" on page 28.](#)

- **Reorder** - Drag any preset up or down and drop it into another location within the Presets panel to reorder the presets within the current setlist. When the preset is dropped in the new location, the surrounding presets are shifted upward or downward accordingly.
- **Transfer to or from Helix/HX Hardware** - With a Helix or HX device connected, you can drag a preset directly from Helix Native plug-in's Presets panel and drop directly into the Presets panel of the HX Edit application to import the preset into your Helix device. Likewise, you can drag a preset from the HX Edit app into Helix Native to import your device's library presets into the plug-in (also see ["Preset Compatibility with Helix and HX Devices" on page 13.](#))

Importing and Exporting Setlists

The Presets panel allows you to Export to save a copy of the currently loaded setlist, including all its presets, to a Helix setlist file (.hls). This is very handy for making a backup of all presets within a setlist, so that a group of presets can easily be imported back into the plug-in's Library in a single action. Setlists are exported in the format matching the current HC mode in use within Helix Native.



To Import a Setlist - Click **Import Setlist**.* This will prompt you to ensure that you wish to **replace the currently selected setlist** and its presets within the plug-in's Presets Library. Continue through the "Open" window to select the setlist you wish to import.



***NOTE:** If you import a setlist that was created with a different source HC mode (or from a different source device) than currently in use, Helix Native will attempt to translate its presets for the current HC mode. (See ["Preset Translation" on page 15.](#))

To Export a Setlist - Click the **Export Setlist** command to save a copy the current setlist as a Helix setlist file on your hard drive.

Changing Setlists

(Available only when in the Helix or Off HC modes) To change the active setlist shown within the Presets panel, click on the Setlist menu and choose from among the 8 setlists stored within the plug-in's Library. The currently-selected setlist will be indicated with an “open folder” icon in the menu.

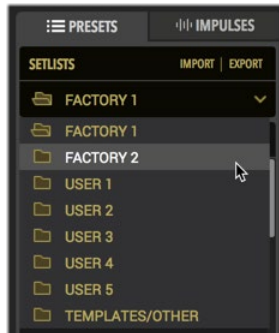

Choosing a new setlist from the setlist menu

Note that no new preset is loaded from within the new setlist until you specifically double-click on a preset from within the new setlist.

Renaming Setlists

(Available only when in the Helix or Off HC modes) To rename the current setlist, right-click on the current setlist's name within the Setlist menu and enter your new title.

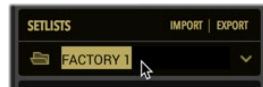

Renaming the current setlist

Importing and Exporting Helix Bundles

(Available only when in the Helix or Off HC modes) A Helix bundle file (.hbl) includes all 8 setlists that make up the plug-in's current Library, including all presets and saved settings, all wrapped up in a single, tidy package. This makes it easy to store a backup of your complete Presets Library—and easily restore your Helix Native Library by importing the bundle. Setlists are exported in the format matching the current (Helix or Off) HC mode in use within Helix Native. The options for importing and exporting a Bundle are found within the Preferences > Presets/IRs tab (also see [page 56](#)).

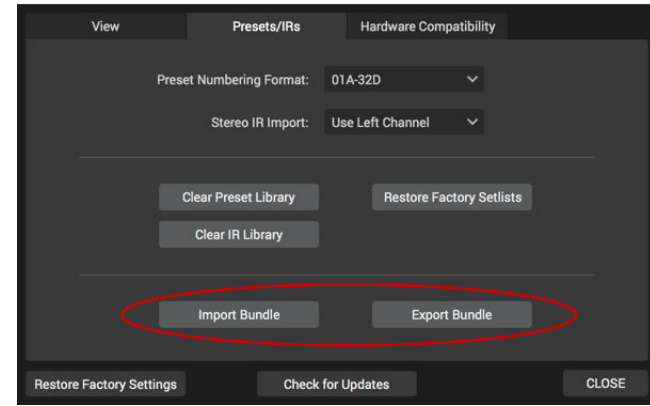

Use the Import/Export Bundle buttons in the Preferences - Presets/IRs window

To Import a Bundle - Click the **Import Bundle** button found in the Preferences > Presets/IRs tab.* This will prompt you to ensure that you wish to **replace all setlists and presets within your Presets Library** with those from the selected bundle file. Continue through the “Open” window to select the bundle you wish to import.

***NOTE:** If you import a bundle that was created with a different source HC mode than currently in use, Helix Native will attempt to translate its presets for the current HC mode. (See [“Preset Translation” on page 15.](#))

To Export a Bundle - Click the **Export Bundle** button found in the Preferences > General window to create a copy of the plug-in's complete Presets Library as a Helix bundle (.hbl) file, stored on your computer.

***NOTE:** Bundle files do not contain any of the Impulse Response (IR) files that you may have imported into the Impulses Library. You can separately export IRs from within the Impulses Panel—see [“Importing and Exporting Impulse Responses” on page 24.](#)

Impulses Panel

The Librarian's **Impulses Panel** provides a list of up to 128 Impulse Response files (along with their respective index numbers), which are available to all instances of the Helix Native plug-in. Initially, this Impulses panel is empty, awaiting you to import Impulse Response files. Once imported, Helix Native presets will access the IRs displayed within the Impulses panel by their index number only. Impulse Response files themselves are not directly associated with presets.*

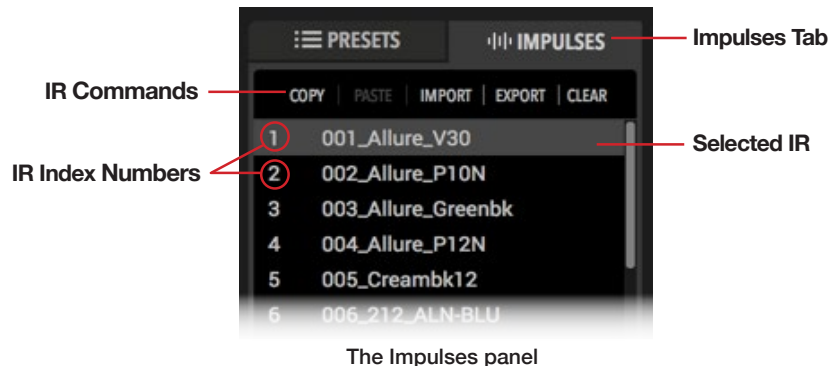

The Impulses panel

Impulses Tab - Click on this tab to display the Impulses panel.

IR Commands - Click on any command in this row to perform its action on the currently selected IR(s).

IR Index Number - Each IR slot includes an Index Number at its left. This index is what is referenced by an IR block within a Helix preset, allowing the block to utilize whatever actual IR file is imported into this IR Library slot.

Selected IR - Click once on any IR in the panel to select it, and you'll see it appear highlighted, as shown above. The selected IR is the one that is acted upon when choosing any available IR Command.

 ***NOTE:** Unlike the Helix Native Presets Library, where each Hardware Compatibility mode includes its own, individual Preset Library, the Impulses Library is a common library, shared between all HC modes in the plug-in. Therefore, IR blocks within all your presets, regardless of the current HC mode in Helix Native, will always reference the index numbered slots within this same IR list.

What are Impulse Responses?

Impulse Responses (or "IRs") that can be used in Helix Native are audio files that are the result of capturing the sound of a test tone (frequency sweep) through a guitar or bass amp speaker cabinet, which has been de-convolved with the original tone signal. This represents the frequency response of the cabinet itself and can be used to simulate the way it alters the sound. This is similar to a convolution reverb, but with a much shorter decay.

You can add an IR block to your preset as an alternative to using one of the Cab blocks to provide speaker cabinet simulation along with an Amp block. Several companies now offer large selections of professionally recorded IRs that can be used in Helix Native, or you can even do some research on how to record and create your own.*

You can also find some IRs that were created using this convolution process to capture the properties of acoustic guitar bodies, guitar pickups and other items. These IRs can be used in the Helix Native or Helix & HX devices' IR blocks, to allow even deeper tone sculpting!

 ***TIP:** Helix IRs are now available for purchase from the online Marketplace, which you can access directly right from inside Helix Native plug-in (version 1.7.0, and later). Please see ["Marketplace & Account Options" on page 58](#).

IR Formats and Restrictions

Once imported, files are automatically conformed to the Helix-compatible IR properties (48kHz, 16-bit, Mono, 2048 or 1024 samples). For Helix Native plug-in, as well as for all Helix and HX devices, the following IR file types are supported.

- **Helix Impulse Response (.hir)** - This is the proprietary Line 6 IR file format. All IRs purchased through the Marketplace are of this file type. Please also see ["Marketplace & Account Options" on page 58](#).
- **WAV (.wav)** - Most IR producers and vendors typically offer IRs within the .wav format. It is possible to import a mono or stereo .wav file IR, regardless of its bit depth, length, or sample rate frequency. Once imported into Helix Native or Helix hardware, files are automatically conformed to the Helix-compatible IR properties (48kHz, 16-bit, Mono, 2048 or 1024 samples). Please be careful to import only .wav files that were created specifically for use as IRs, not just any audio .wav file, or you may experience unexpected sonic results.

 **Helix and HX Device Users:** If you plan on utilizing your Helix Native presets in both Helix Native plug-in and your Helix or HX hardware, the best practice to import the same exact IR files into both, and in the same IR list order. This allows all IR blocks to reference and load the same indexed IR files for all presets that use them. Please also see ["Preset Compatibility with Helix and HX Devices" on page 13](#).

Importing and Exporting Impulse Responses

To Import an IR - Click once to select the desired index location within the Impulses panel and then select the **Import** command button at the top of the Impulses list. Continue through the File-Open window to select the desired IR file. If you select multiple IR files, they will all be imported into contiguous index locations.

Premium Marketplace IRs

If you've purchased and downloaded premium IRs from the Line 6 Marketplace online shop, you must initially have Helix Native signed in, and your computer authorized to allow the Import or Export and license synchronization for these IRs.*

***NOTE:** The authorization required for your Helix Native license also covers the use of any Marketplace premium assets on this computer—both within Helix Native and the Line 6 HX Edit application. Please see [“Authorizing your Computer” on page 5](#) and [“Marketplace & Account Options” on page 58](#).

When premium Marketplace IRs (.hir files) are imported, they are indicated by a guitar pick badge to their right within the Impulses panel.

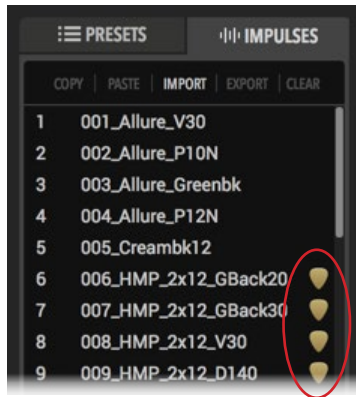

Premium Marketplace IRs are indicated with a guitar pick badge

To Export an IR - Select the desired IR(s) within the Impulses panel and click the **Export** command to display the Save As dialog.* You may also drag & drop to and from the Impulses panel to import and export IRs—see the following section.

***TIP:** Exporting your complete list of IRs is a nice way to keep a backup of them all in one place on your computer. It is helpful to rename your exported IR files to include their stored index ID number at the start of the title (001 through 128, as shown in the image at the start of this chapter) to easily identify what IR slots they should be imported back into.

Renaming, Loading, Copying, and Clearing IRs

These functions can be performed by clicking the command buttons above the Impulses index list and will act upon the selected (highlighted) IR. You can also right-click on any IR slot to choose these options from the context menu.

***TIP:** We've also provided a handy **Clear IR Library** option, to clear out all IRs from the plug-in's current IR Library in one click—see [“Preferences - Presets/IRs Tab” on page 54](#).

Drag and Drop IRs

There are several drag and drop options that allow you to import and export single or multiple IR files between your computer's hard drive directories and Helix Native, as listed below.

- **Import** - Drag one or more IR (.hir or .wav) files from your computer's hard drive folder directly into the Impulses panel. When multiple files are being dragged in, they are imported in sequence, starting with the selected IR index slot.
- **Export** - Select one or more IR index locations in the Impulses panel and drag directly to your computer to export the IR files to the selected hard drive folder.
- **Load** - Select any of the 128 index slots which contains an imported IR file and drag and drop it directly onto a path within the current tone's Signal Flow to insert an IR block, and load the selected IR within the block. (Also see the following “Loading an IR” section for more options.)
- **Copy** - It is also possible to drag and drop IRs *within* the Impulses list view to create a copy of the IR in a new index location.*

***NOTE:** There are intentionally no options to move or reorder IRs in a single operation. Use the **Copy** and **Clear** functions to rearrange IR within the Impulses list as needed.

- **Transfer To/From Helix Hardware (for Helix/HX device owners)** With a Helix or HX device connected, drop an IR from the Helix Native plug-in's Impulses panel directly into the Impulses panel of the HX Edit application. It is also possible to drag an IR from HX Edit into the Impulses panel of Helix Native to import a copy of the same IR file.

Loading an IR in an IR Block

When you insert an IR block within your preset's Signal Flow, it initially defaults to referencing the #1 IR index location (if you have not yet imported any IR file into the referenced index location, the “empty” IR block has no effect on the signal).

To follow are a few methods for loading an IR into an IR block, which determines the IR file that is associated with the IR block (also see [“IR File Reference” on page 26](#) for additional behaviors).

Use the Edit tab's IR Select slider - Select the IR block within the Signal Flow, then, in the **Edit** tab, use the **IR Select** parameter slider (or its menu at the right) to select IR index number (1-128) that includes the desired IR.

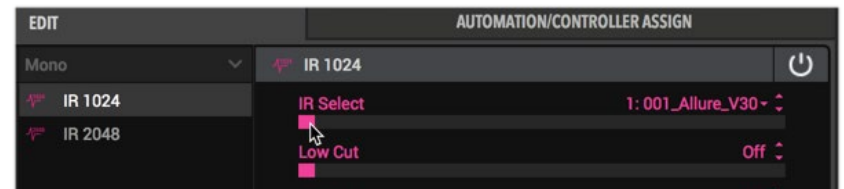

Choosing an IR by its Library index number within the Edit tab

Double-click in Library - Select the IR block within the Signal Path and then double-click on the preferred IR within the Impulses Library list to load into the IR block—replacing any currently referenced IR. Note that no action is performed if you do not have an IR block selected.

Drag and drop - As mentioned in the preceding section, you can also add an IR block already loaded with an IR by dragging the desired IR from the Impulses Library panel and dropping it directly into an empty location within your Signal Path. (Drag and drop from the IR Library always adds a 1024 Sample type IR block.)

You can use the other IR block parameter sliders in the Edit tab to further shape the IR's tone and level—see [“Editing Model Parameters” on page 41](#). Once done selecting an IR and its parameter options, be sure to save the preset to retain your IR block settings.

 **TIP:** Optionally, you can create a snapshot assignment (see [page 32](#)) on the IR Select parameter, which then allows you to change the block's associated IR as desired, per snapshot!

Whenever you load a preset that includes one or more IR blocks that reference an empty IR index location, a pop up is displayed to alert you. For example, the alert shown below is telling you that the preset includes two IR blocks, on Paths 1A and 1B, which cannot locate their originally associated IR files. The “Position” denotes the block position of each IR block from left to right on the path, starting with “0” for the left position. Please see the next section for more related IR behaviors.

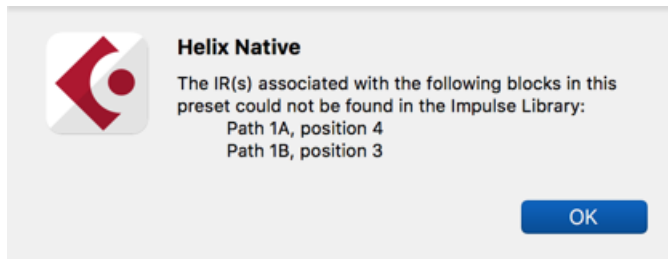

Missing associated IR(s) alert pop-up

IR File Reference

Once an IR block is configured to utilize an IR index slot that includes an imported IR (.wav or .hir) file, and the preset then saved (using Helix Native version 1.90 or later), the preset creates a “reference signature” to the imported IR from its file name. Therefore, even if you re-order IRs within the IR library list, your preset will still intelligently reference the originally associated IR file, even if it now resides in a different IR Library index location. The following behaviors apply:

- If you **clear** or **replace** the IR file within the IR index slot for which the preset's IR block is configured to use, upon the load of the preset, the IR block will first attempt to locate another instance of the missing, associated IR file within the Impulses Library and automatically utilize it and its residing index slot. You'll be alerted if the original associated IR is not found within the IR library (see previous section).
- If the configured IR index slot is currently empty, you'll be prompted with an alert (see previous section) that the IR block's associated IR file cannot be found, and the IR block continues to utilize the same (now empty) IR index slot. You'll want to configure the IR block to utilize an occupied IR index slot (or import an IR into the currently referenced slot) and save the preset.
- If the original IR file is cleared from Library, and the IR index slot includes a different IR file, you'll be prompted that the associated IR cannot be found, and the IR block utilizes this new IR file within the configured index slot. You'll need to save the preset with this reference to the new IR (or configure the IR block to use a different, occupied IR slot) to avoid seeing the alert pop-up on future loads of the preset.
- Once an IR block is configured with an occupied IR Library index selection, and the preset then saved, the IR (.wav or .hir) file retains this reference signature when exported from the library—thus, even if you import the exported IR file again into any index slot within your Impulses Library, the saved preset's IR block will still be able to locate and utilize it.*

Yes, the above rules all sound a bit complicated, but in typical use, all this really just means that if you happen to move your IRs around in the IR Library list, your saved preset will now not lose their link to them!

 ***NOTE:** The IR file reference functionality is also incorporated in the HX Edit software. Therefore, Helix and HX hardware presets exported from HX Edit will exhibit the same behaviors and attempt to locate their referenced IR .wav files from within the Helix Native IR library upon loading within the plug-in. Likewise, presets exported from Helix Native will attempt to locate their IR blocks' referenced IR .wav files when loaded within HX Edit. The moral of the story here is simply to import the same IR .wav files into both HX Edit and Helix Native if you plan on sharing your crafted presets between them, and the proper IRs will automatically be utilized from your IR library, regardless the IR slots where they reside.

Working in the Plug-in Editor

To the right of the Librarian panels is the Editor UI of the plug-in, which consists of a top row of options, the Signal Flow and Inspector windows, offering a multitude of options for adding & configuring processing blocks, signal routing & parameter automation configurations. See the following sections for details on using these user interface elements. Note that the Signal Flow layout changes within the plug-in differ depending on the selected Hardware Compatibility mode that is in use. We've called out within the following sections where options and behaviors differ between HC modes. Please also see [“Hardware Compatibility Modes” on page 13](#).

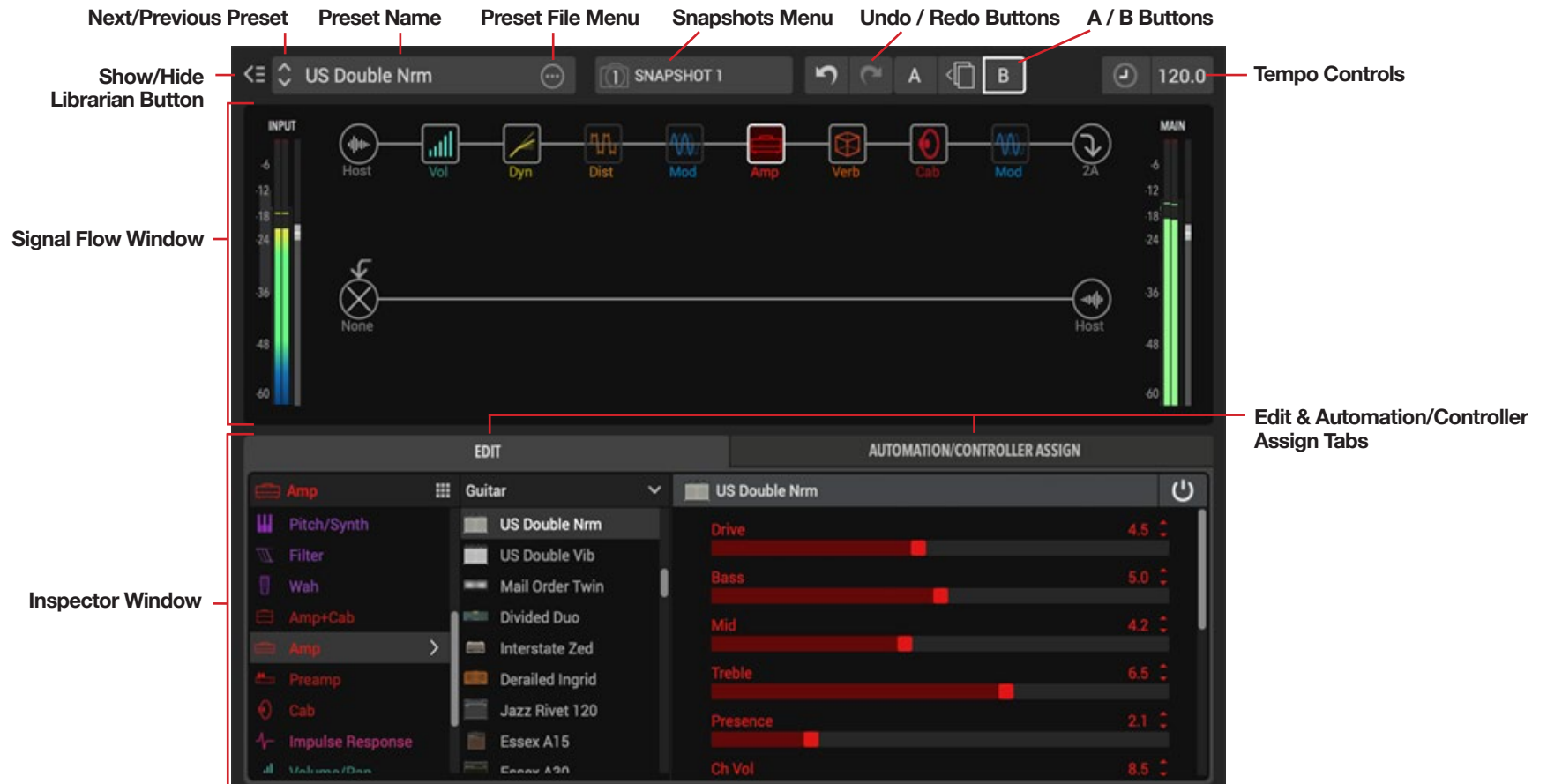

Navigating with the Next/Previous Preset Buttons

These buttons provide an easy way to increment forward and backward within the current plug-in Library setlist, instantly selecting and loading the next/previous preset into the Signal Flow window. If you wish to have these buttons navigate through a different setlist, choose the desired setlist from the Setlist menu at the top of the Presets panel.

Naming the Preset

The **Preset Name** field displays the name of the most recently loaded Helix preset. Double-click on the text here to optionally rename the preset.

NOTE: When you edit the preset title or make any other changes to the preset's settings after initially loading it, be sure to use the **Save to Library** or **Save to Disk** options found within the Preset File menu (see next section) if you wish to retain your changes within a preset that can be utilized by other Helix Native instances!

Using the Preset File Menu

To the right of the Preset Name field is the **File menu** which includes options for the current tone.

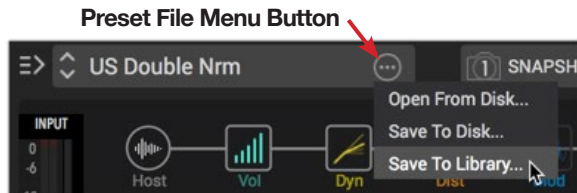

- **Open From Disk** - Allows you to load a saved preset from your collections of Helix preset (.hlx) files saved on your computer. This differs from using the Import command found within the Presets panel in that it loads the preset directly into the Signal Flow without also importing the preset into the plug-in's Presets panel library. If you edit this loaded preset and wish to save your changes, use the Save options, as described below. (Also see [“Loading vs. Importing Presets into Helix Native” on page 13.](#))
- **Save To Disk** - Exports the currently loaded tone to your computer, offering you the option for your specific save location.
- **Save To Library** - Allows you to choose any preset location within your Presets panel to save the preset into the plug-in's internal Presets Library.

Configuring and Loading Snapshots

The **Snapshots Menu** allows you to load and edit the snapshots available within each preset, providing instant recall of assigned parameter value changes, block bypass states and more, in one click.

NOTE: To follow is a quick description to get you going, but the snapshots feature is a big enough topic that we've dedicated an entire chapter to it. Please see [“Working with Snapshots” on page 31.](#)

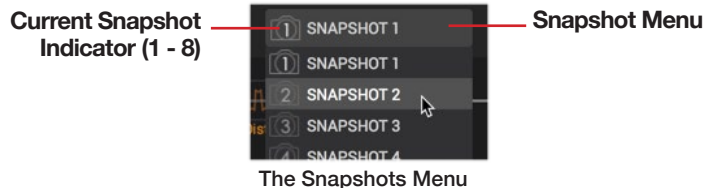

- **To Configure and Edit a Snapshot** - Click on the Snapshots Menu and select the snapshot index number you wish to edit, then configure all desired options for your current tone's block bypass states, tempo and snapshot controller-assigned parameters' values. Your changes are stored automatically for the current snapshot index number. Be sure to **Save** your tone to permanently retain your snapshot settings with the preset.

- **To Load a Snapshot** - Simply choose the desired snapshot index number from the menu and all the settings configured for the snapshot are recalled instantly.

TIP: Snapshots can also be loaded in real-time via your DAW host's plug-in parameter automation functionality—see [“Automating Snapshot Changes” on page 48.](#)

Undo and Redo

Helix Native supports Undo and Redo for most edit actions performed within the plug-in window, accessible via the Undo and Redo buttons at the top of the main plug-in window. The Undo / Redo history is tracked per instance of the plug-in.



The Undo and Redo buttons

Undo / Redo is available for most actions performed in Helix Native, including:

- Parameter changes
- Snapshot changes
- Changing block models
- Signal Flow view changes (adding/cutting/clearing blocks, changing path structure, etc.)
- Master Input and Output Level sliders
- A/B Compare functions (see next section)
- Preset changes*

***NOTE:** Loading a preset from the Presets Library window (or using the **Open From Disk** command within the Preset File Menu at the top of the Signal Flow) is undo-able, but most other actions performed within the Library window are not. A few other limitations apply to Undo for preset changes—please also see the following list of unavailable Undo actions for details.

Actions *not* available for Undo / Redo include the following:

- Tempo changes
- Adding, editing, and removing automation, snapshot, bypass, and controller assignments

NOTE: When Undo restores the removal of a block that includes assignments, in most cases, these assignments are restored with the block, but in some cases may not be able to be retained.

- Edit actions performed via automation controllers and MIDI CC messages
- Setlist and preset loading done via MIDI Bank/Program Change, CC messages, or via automation*
- Pasting a copied snapshot
- Changes to any settings within the Helix Native Preferences window
- Changing the Hardware Compatibility mode, either via the Preferences window HC mode selection, or via loading a preset from a different device/HC mode source (also see [“Hardware Compatibility Modes” on page 13](#))
- Actions performed within the Presets and IR Library windows (e.g., importing, reordering, or pasting presets or IRs, etc.) Note that loading a preset by double-clicking on it directly within the Presets Library *is* supported within Helix Native—see next point
- Undo for the action of loading a preset is supported, with a few limitations:
 - Loading a preset which *also* includes a HC mode change is not supported by Undo, and will *clear the current Undo history*
 - Any preset change performed via MIDI PC/CC messages or automation will also *clear the current Undo / Redo history*

NOTE: Host DAW applications also typically offer their own Undo / Redo commands, and some also offer “A/B Compare” features as well. However, due to the complex architecture of Helix Native, these types of host commands typically cannot track most actions performed within the plug-in. Therefore, we suggest you use only the built-in Undo / Redo within Helix Native for restoring its actions.

Using the A/B Compare

The set of A/B Compare controls allow you to temporarily store all your current Helix Native parameter settings as a starting point for further fine-tuning, and then easily compare new, edited settings with the original settings.



The A/B Compare controls

NOTE: DAW host applications often include their own A/B Compare feature for effects plug-ins. However, since Helix Native is a complex effects plug-in with its own Presets Library and numerous parameters, it is recommended you use this A/B Compare within Helix Native for its settings.

Also note that these A/B Compare controls are also supported by Undo/Redo, allowing you to reverse the actions performed by the **A**, **B**, and **Copy To** buttons.

To follow is an example for how to use this feature.

1. Start with the **A** button selected. Once you have loaded a preset or created a tone to your liking within the Helix Native Signal Flow, click the middle **Copy To B** button.



Copy A to B

This copies all the plug-in’s current parameter settings to the **B** location, providing you with a stored “starting point” for further adjustments.

2. Select the **B** button and proceed to edit your tone to fine-tune it as desired. Note that you can make any type of edits you like within the plug-in—adjust sliders, bypass/move/add/clear blocks, add/edit/remove automation & controller assignments, or even load a different preset.
3. You can now switch between both settings by clicking the **A/B** buttons while playing your track and audibly compare between them.
4. Optionally, while the **B** button is selected, you can make further adjustments and continue comparing to your original **A** settings.
5. If you decide you still prefer your original settings, simply switch back to, and remain on, setting **A**.

If you decide you prefer your edited settings, with the **B** button selected, copy the **B** settings to the **A** location by pressing the **Copy To A** button.



Copy B to A

This allows you to have these settings now stored in both **A** and **B** as your new “starting point,” from which you can repeat the steps 3-5 for further fine-tuning.

All your current settings for **A** and **B** remain stored within the plug-in instance for the host DAW project.

Editing the Tempo

There are a few options available for configuring the tempo that is utilized by the plug-in, accessible from the controls at the top of the Signal Flow window. Any of the current tone's effects blocks that are set to note division values (a **Note Sync** option is available for most delay and modulation effects within the Edit tab—see [page 41](#)) will follow this tempo value.

Tempo Select Menu

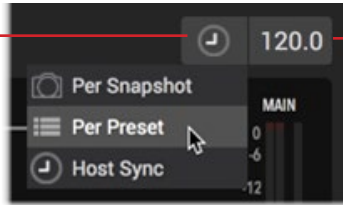

Numerical Tempo Field & Tap Tempo Button

The Tempo controls

How the Tempo Value is Recalled

Use the **Tempo Select Menu** to select how the tempo value is utilized and recalled.

- **Per Snapshot** - The tempo value will be stored and recalled individually with each snapshot (see [“Working with Snapshots” on page 31](#) for details).
- **Per Preset** - The tempo value will be stored and recalled individually with this preset.
- **Host Sync** - The tempo value follows the timeline tempo of the host DAW project for any preset loaded within the plug-in instance. Note that even if your DAW project has timeline tempo changes automated, Helix Native will follow when using this setting! This is the initial default setting for the plug-in.

Entering a Tempo Value

To the right of the Tempo Select Menu is a combined **Numerical Tempo Field** and **Tap Tempo Button**. When you have selected the **Per Snapshot** or **Per Preset** tempo modes in the menu (as noted above, when set to **Host Sync**, the plug-in tempo will dynamically follow that of your host project), you can enter a tempo here in two ways:

- Right-click to type in your desired numerical tempo value.
- Click rhythmically to “tap” in your preferred tempo.

Show or Hide the Librarian Panel

Click the button at the top left of the Signal Flow window to either display or collapse the Presets & Impulses Librarian Panel. Also see [“Customizing the Helix Native Plug-in Window” on page 11](#).



The Librarian Panel's Show/Hide Button

Working with Snapshots

Within Helix hardware devices and within the Helix Native plug-in, it is possible to create & customize up to 8 “snapshots” within a preset.* Snapshots can store a set of options (a block’s bypass state, snapshot-assigned parameter values, and tempo settings), and then recall them without the brief lag time and audible signal drop-out typically associated with changing presets.

***NOTE:** The number of snapshots available within a preset differs depending upon the Helix Native Hardware Compatibility mode in use, or the source device type, as follows (please also see [“Hardware Compatibility Modes” on page 13](#)):

- Helix HC mode and Helix Floor, Rack, and LT devices include 8 snapshots per preset.
- HX Effects HC mode and HX Effects devices include 4 snapshots per preset.
- HX Stomp HC mode and HX Stomp devices include 3 snapshots per preset.

Also note that, if you load or import a preset into a Helix Native instance that is configured to a HC mode that supports fewer snapshots, the unsupported snapshot settings will be discarded for the preset.

Configure any snapshot(s) with your desired settings for the current tone within Helix Native, and then recall any snapshot from the Snapshots menu, via your DAW host’s parameter automation or via external MIDI control (MIDI CC 69—see [page 52](#)). Snapshots created and exported from Helix/HX devices (via the HX Edit application) are also supported within Helix Native, and vice-versa. This all presents some extremely powerful mix capabilities in your DAW, with the ability to instantly recall and change numerous Helix Native parameter settings in real-time!

TIP: Don’t worry, you actually don’t need to utilize or even understand anything about snapshots if you don’t want to right now! You can completely ignore them and edit your presets without accessing them at all. But if you want to explore the possibilities, please keep reading this chapter.

Similar to the snapshots feature in some high-end digital mixers, each Helix Native snapshot stores and recalls the state of certain elements within the current preset, including:

- **Block Bypass** - The bypass (on/off) state of all processing blocks, independent of any footswitch assignments—see [“Snapshots > Block Bypass”](#)
- **Parameter Control** - The value of any parameter assigned to a snapshot controller (up to 64 per preset)—see [“Snapshots > Parameter Control”](#)
- **Tempo** - The current system tempo, if the Tempo Select is set to **Per Snapshot**. (By default, it’s set to **Per Preset**.) See [“Editing the Tempo” on page 30](#).

Depending on how you configure them, snapshots can act as multiple variations of the same tone, multiple different tones, or any combination thereof—all within the same preset.

The Snapshots Menu

Snapshots are accessed via the **Snapshots menu** at the top of the Helix Native plug-in main window. The index number displayed within the little camera icon within the Snapshots menu tells you which of the preset’s snapshots is currently loaded. Click the menu to select and load a different snapshot. Ctrl+click / right-click directly within the menu to rename the current snapshot as desired. Also see [“Configuring and Loading Snapshots” on page 28](#).



Snapshots > Block Bypass

Snapshots automatically store the current bypass (on/off) state for all processing blocks. Therefore, all block bypass states are recalled when jumping from snapshot to snapshot, and appear as you *last left them*. (It is also possible to exclude any block’s bypass from being controlled via snapshots—see [“Per-Block Snapshot Bypass Option” on page 32](#).)

For example, with Helix Native in the Helix HC mode, here’s a scenario where you might configure and name snapshots to toggle the desired blocks on/off for each section of your song.

Snapshot 1—INTRO could have Distortion 1, Amp 1, Cab, Mod 1, and Delay 1 on:



Snapshot 2—VERSE could have Dynamics, Distortion 2, Filter, Amp 2, Cab, IR, Delay 2, and Reverb on:



Snapshot 3—BRIDGE could have Dynamics, Amp 2, IR, EQ, Mod 2, and Delay 2 on:



Snapshot 4—CHORUS could have everything on:



And **Snapshot 5—INTERLUDE** could just be Amp 1 and the IR:



Note that all snapshots in a particular preset share the same models; you cannot, for example, add a US Deluxe Amp block in Snapshot 1 and switch its model to Essex A30 in Snapshot 2. However, (if the current Helix Native instance has not reached its HC mode's maximum processing limit), you can load both amp blocks into the same preset and snapshots can enable neither, one, or both of them.

Per-Block Snapshot Bypass Option

As covered above, the default behavior for all amp & effects blocks is that their bypass state is automatically controlled by snapshots. But if you prefer to exclude a block from being controlled by snapshots, select the block and set the **Snapshot Bypass** option from the block's right-click / Ctrl+click menu to "off" (so that no check mark appears at the left of the menu option). Or, you can right-click on the block's Bypass button within the top right of the Edit tab and access the Snapshot Bypass command from its menu. Choosing the command from the menu again (so that the check mark appears), returns the block to the default snapshot behavior.

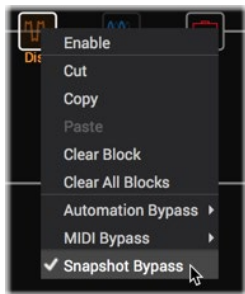

Block right-click menu

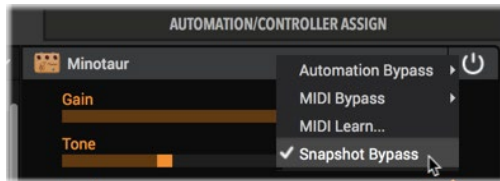

Edit tab - Block Bypass button right-click menu

The Snapshot Bypass command within the block context menu

Snapshots > Parameter Control

In addition, parameters can be set to jump to specific values with each snapshot. Here's an example, again using the Helix HC mode in Helix Native, where seven parameters' values (out of a possible 64) are updated instantly with each snapshot:

Snapshot	Amp Gain	Delay Mix	Split A/B	Pitch	IR Select	Volume Level
1 INTRO	4.5	35%	Path A 100	0	#27	-7.2dB
2 VERSE	4.5	35%	Path A 100	+5	#27	0.0dB
3 BRIDGE	5.2	43%	Path B 100	+3	#103	+0.8dB
4 CHORUS	4.5	50%	Path B 100	0	#103	+1.5dB
5 INTERLUDE	3.9	8%	Even Split	+5	#27	0.0dB
6 SOLO	8.7	72%	Path B 100	+12	#103	+2.6dB

Snapshot	Amp Gain	Delay Mix	Split A/B	Pitch	IR Select	Volume Level
7 BREAKDOWN	2.0	46%	Path B 47	-12	#12	0.0dB
8 OUTRO	4.5	35%	Path A 100	0	#41	-3.6dB

In the preceding table, we see that when changing from **Snapshot 2—VERSE** to **Snapshot 3—BRIDGE**:

- The Amp block's Gain increases from 4.5 to 5.2
- The Delay block's Mix increases from 35% to 43%
- The Split block routes your guitar from Path A to Path B
- The Pitch block's Interval lowers from +5 to +3 semitones
- The IR changes from index #27 to #103
- The Volume block's Level increases from 0.0dB to +0.8dB

If you want a parameter to be automatically updated with each snapshot, the parameter must first be assigned to a snapshots controller, as covered in the next section.

Assigning a Parameter to the Snapshots Controller

As covered in the preceding Snapshots > Block Bypass section, the bypass state of any block is automatically stored and recalled per snapshot. However, for other parameter types, it is necessary to first create a snapshots assignment to allow the parameter's value to be stored and edited per snapshot.

1. Within the Signal Flow window, select the block which includes the parameter you wish to control via snapshots. For this example, we'll choose the Litigator Amp+Cab block so we can control the amp's **Drive** parameter.
2. In the Edit tab, right-click on the Amp's Drive parameter and choose the **Snapshots** option.

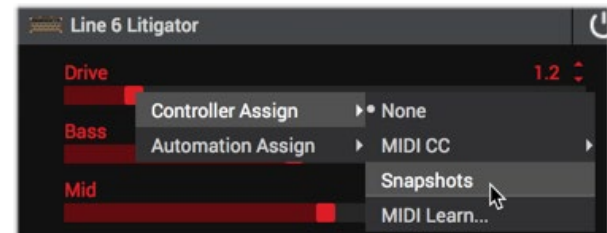

Assigning the Drive parameter to the Snapshots controller

3. You'll see a little camera icon at the left, and the parameter's value at the right appear in white with brackets, to indicate the snapshots controller assignment.

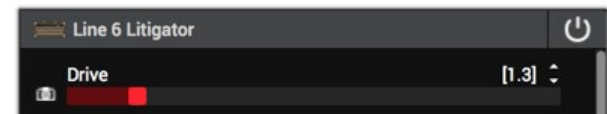

- Now you can simply load any snapshot and set this Drive slider to the desired value. The value is independently stored and recalled with each snapshot.

Each preset can have up to 64 controller assignments, including parameters controlled by snapshots. *Remember to save your tone if you want your assignments to be permanently stored with the preset!*

- All existing snapshots assignments appear within the Automation/Controller Assign tab's Assignment List.

If desired, you can right-click on the assignment here and choose **Clear Assignment** to remove it.



Once a snapshots assignment is created, any changes to the value of the assigned parameter is instantly stored with the current snapshot. These stored values are recalled when jumping from snapshot to snapshot, and appear as you *last left them* per snapshot.

Copying, Pasting & Renaming Snapshots

You can copy & paste all snapshot settings from one snapshot to another within the current tone as a time-saver for when you want to just change a few settings. You can optionally rename your snapshots to help you remember the intended purpose of each. These snapshot commands are available via right-click on the Snapshots menu.

To Copy & Paste a Snapshot - Select and load the snapshot you wish to copy and select **Copy** from the Snapshots right-click menu. Then load the snapshot you wish to overwrite and choose **Paste** to paste the clipboard contents, replacing the currently loaded snapshot.

To Rename a Snapshot - Right-click on the currently loaded snapshot from the Snapshots menu and select **Rename**. Type in your new name, then press Enter/Return on your keyboard.

NOTE: The action of pasting a copied snapshot and/or its snapshot title is not tracked by the Helix Native Undo / Redo.

Tips for Creative Snapshot Use

- As in the preceding examples, configure and name a dedicated snapshot for each section of your song: Snapshot 1 for the Intro, Snapshot 2 for Verse 1, Snapshot 3 for the Chorus, and so on. Then use your host DAW's parameter automation to load the snapshots in real-time!
- Worried that further tweaking might make your tone worse, not better? Snapshots are a great way to compare minor changes between tones without losing your settings.
- Turn any Delay or Reverb block's Trails parameter to "On" for seamless spillover between snapshots.
- Set different keys in Harmony Delay blocks or intervals in Pitch blocks per snapshot.
- Having difficulty maintaining consistent volume levels throughout a song? Set the Output block's Level parameter per snapshot.
- Recall snapshots via an external MIDI controller device or software using the dedicated MIDI CC 69—see ["Global Reserved MIDI CCs" on page 52](#).
- Rename your snapshots uniquely within a preset to define their purpose—see the previous section.
- Don't want a block's bypass state to be recalled per snapshot? No problem—you can exclude any block from snapshot bypass control within the block's right-click / Ctrl-click menu—see ["Per-Block Snapshot Bypass Option" on page 32](#).

NOTE: All snapshots assignments and settings are retained within the current tone's preset until another preset is loaded within the plug-in. If you wish to permanently retain all your snapshot assignments and settings with the preset, be sure to use the File menu options to **Save** your tone to the Presets Library or to Disk. The snapshot that is in use when you save your preset is the one that is recalled when the preset is loaded again.

The Signal Flow Window

The **Signal Flow Window** displays the plug-in's input and output blocks, levels, and all processing elements, laid out in the actual flow in which your DAW audio signal is routed through it. When you click on any input, output or processing block and select it here, you can then access the block's model & parameter options within the **Edit tab**, or its automation options within the **Automation/Controller Assign tab** below.

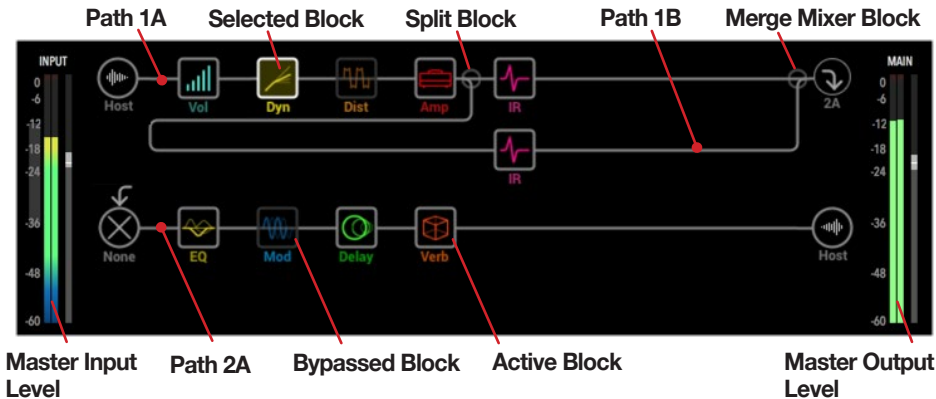

The Signal Flow Window (Helix or Off HC mode)

As covered in [“Hardware Compatibility Modes” on page 13](#), the Signal Flow display within Helix Native will appear differently depending on the Hardware Compatibility mode you have selected, effectively matching the Signal Flow (path structure and block capacity) of the respective device. When using the Helix or Off HC mode, the Signal Flow appears as shown above, matching the Signal Flow of a Helix Floor/Rack/LT device.

When the HX Stomp or HX Effects HC modes are selected, the Signal Flow matches the respective hardware device's Signal Flow, as shown below.

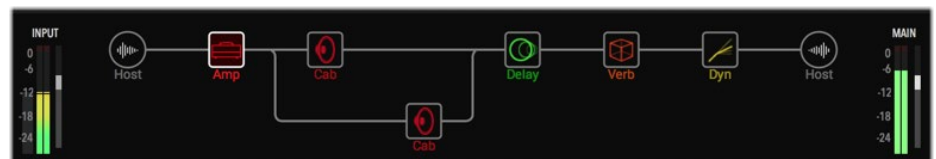

The Signal Flow Window (HX Stomp HC mode)

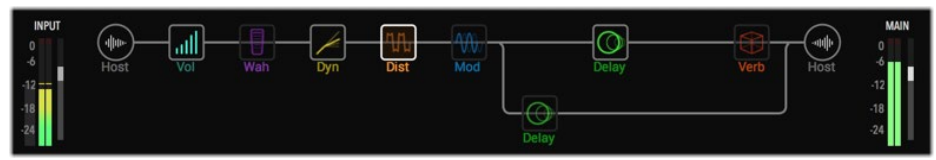

The Signal Flow Window (HX Effects HC mode)

NOTE: Throughout this chapter, all features and instructions apply with any HC mode in use in Helix Native, unless specifically noted.

Show/Hide Block Labels Option

If you prefer a cleaner look within the plug-in's Signal Flow window, you can “hide” the descriptive text labels that appear below each block using the Show/Hide option within the **Preferences > View** screen (see [page 54](#)). When set to hide the labels, you'll only see a block's label appear when hovering your mouse over the block.



NOTE: The Show/Hide Labels function affects all Helix Native plug-in instances globally. (However, you may need to close any other currently open plug-in instance's window and re-open it again before a change in this setting is applied.)

Block Bypass Assignment Indicator

If you create a bypass assignment (either via an automation or MIDI type assignment) for any amp or effects block within your tone, you'll see the block name label displayed in brackets, as shown below. Please see [“The Automation/Controller Assign Tab” on page 43](#) for the full info on creating bypass assignments. (Note that if you happen to have the above-mentioned Show/Hide Block Label option set to “Hide” you won't see these labels or indicators.)



Bracketed block label indicate a block bypass assignment

Master Input & Output Level Controls

At the left and right of the Signal Flow are the Master Input & Output level sliders, along with real-time level meters. These level sliders' values are not saved per preset and, therefore, offer global control over levels entering and exiting the plug-in. To follow are several tips for using these controls.

Adjusting Levels - Just as with all sliders in Helix Native, the Master Input & Output Level sliders can be adjusted in several ways:

- Click on any slider's “handle” and drag to the desired value.
- Click on the desired range location within a slider's path and it will jump to the clicked value.
- While hovering your mouse cursor over the slider's path, use your mouse wheel to adjust it.
- Double-click anywhere on the slider area and enter a precise numerical value.

Clipping, as indicated by the Clip Indicator at the top of the meter lighting up red, should always be avoided for both the plug-in's input and output.*

TIP: Configuring your input levels into Helix Native is important for achieving the optimal sound from most Amp & Effect blocks. Please see [“Optimizing the Input Level” on page 10](#) for details.

If the plug-in's Output meter is showing very low or high levels, it is best to adjust the blocks that may be cutting or boosting the signal too heavily (Dynamics, Distortions and Amp blocks, for example, all offer Gain or Volume parameters). However, you can always use this Master Output Level slider to optimize the plug-in's final output level.

Reset to Default Level - Cmd+click (Mac) or Ctrl+click (PC) directly on the Input or Output slider to reset to the default (unity gain) value.

Peak Level Display - The numerical, real-time peak level value is displayed at the top of each slider whenever you are adjusting the slider, and whenever you hover your mouse cursor over the slider path.

Adding, Clearing & Bypassing Blocks

To Add a Block to Your Tone - Hover your mouse cursor over the desired location on any path and you'll see an empty block location appear to indicate that a processing block can be added there. Once you click and select the empty location, choose any type of block from the Edit tab's **Model Browser**. Please see [“Selecting Models” on page 40](#) for more info.



Selecting a location in the Signal Flow for a new block

To Clear any Existing Processing Block - Select the desired block and choose **Clear** from the (right-click) context menu, or click the “X” button that appears when hovering your mouse cursor over a block.



When hovering over a block, you'll see its Bypass and Clear buttons appear

Clear All Blocks - Select the desired block and select **Clear All Blocks** from the context menu to remove *all* processing blocks from the Signal Flow. (Input & Output block settings remain unchanged.)

To Bypass or Enable any Existing Processing Block - There are a several ways to bypass or enable a block:

- Whenever you hover your mouse cursor over a block type that offers bypass, you'll see a click-able **Bypass/Enable** button appear (as shown above).

- Select the desired block and select **Bypass** or **Enable** from the block's (Ctrl+click or right-click) context menu.
- Click the **Bypass/Enable** button offered in the Edit tab—see [“Editing Model Parameters” on page 41](#).

Cutting, Copying & Pasting Blocks

It is possible to **Cut**, **Copy** or **Paste** any individual processing (Amp, Cab, IR, or FX) block within Helix Native. To access these commands, click on the desired block within the Signal Flow to select it, then right-click or Ctrl-click to display the context menu.

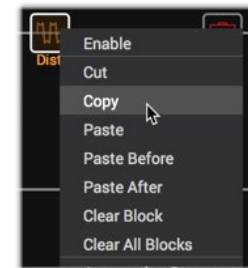

Block context menu - Copy and Paste commands

TIP: You can also use Copy/Paste, or drag and drop, to copy a block between separate Helix Native plug-in instances, or HX Edit device windows, as covered below.

Use **Cut** or **Copy** for a block, and then use one of the **Paste** commands within any Helix Native plug-in instance or within the HX Edit application, as follows:

- Into any path within the same or a different instance of the Helix Native plug-in, and within any preset.
- Into any path within the HX Edit app, and within any preset.

Block Copy / Paste is allowed for all block types (Amp, Effects, Mix, Input and Output blocks), with some restrictions.* This provides great flexibility in re-creating tones between Helix Native, HX Edit, and even different Helix and HX devices.

NOTE: Some restrictions apply for copy/paste of blocks, depending on the maximum block and DSP capacity and features of the particular HC mode in use. For example, just as a Helix Native or device preset will prevent adding some block or model types as the DSP limit is reached, the same DSP limit rules apply for copy/paste. Therefore, copy and paste observes these Block rules as well. Physical inputs & outputs differ between Helix Native and the different Helix/HX devices, therefore, the copying of Mix, Input and Output blocks and their settings may not be allowed, as covered throughout this chapter.

Cut - Clears the block from the Signal Flow and copies the block and its current parameter settings to the clipboard.

Copy - Copies the block and its current parameter settings to the clipboard.

 **NOTE:** When copying a block with existing HX Edit hardware-based assignments, the assignments will not be retained if the destination device does not include or support the specific controller type (e.g., if copying a block with an EXP 3 controller assignment from a Helix Floor to an HX Stomp device (or HX Stomp HC mode in Helix Native), the assignment is not shown or supported, since HX Stomp includes no EXP 3).

Paste - Pastes the most recently cut/copied block into the currently selected block location within the Signal Flow. If you select an existing processing block, this will **replace** the existing block and its settings.

- **Paste Block After / Paste Block Before** - If you select an existing processing block, you can alternatively choose either of these commands to paste the block in your preferred location.
- **Mix type blocks** - Copy & paste are also available for an **Input, Output, Split** and **Merge** type block as well, where its parameter settings can be copied & pasted into a location with the same block type.
- When copying a block within the same window, or between separate Helix Native (and/or HX Edit) windows, existing snapshot assignments are copied with the block, but automation and footswitch-based bypass assignments are not.
- When copying a block from HX Edit to Helix Native, it may not appear that its hardware-based controller assignments are retained, since the Helix Native does not support them, and does not list them in its Assignments tab. But if you copy the same block back into an HX Edit window again, you'll see its original assignments are indeed still intact.

 **NOTE:** When using the Cut command for a block that includes automation (Knob or Switch) controller assignments, the assignments are included in the settings data when copied to the clipboard and included the first time the block is pasted into a new location within Helix Native. When using the Copy command, no existing automation controller data is copied to the clipboard..

Drag and Drop Blocks

You can also use “drag and drop” to copy/paste or move a block, including all its current settings, within the current preset, as well as between separate Helix Native and/or HX Edit windows. Copy or move can be performed with any processing type blocks - Amps, Cabs, IRs, FX (as long as the block type is supported by the target destination’s Signal Flow). The following drag and drop actions are available for blocks.

- Drag and drop of a block anywhere within the current Helix Native Signal Flow **moves** the block (including when dragging between Paths).
- Holding the Alt (Mac) or Ctrl (PC) key and performing drag and drop of a block anywhere within the current Helix Native Signal Flow **copies** the block.
- Drag and drop of a block into the Signal Flow of any other Helix Native or HX Edit app window **copies** the block.

- Holding the Alt (Mac) or Ctrl (PC) key and performing drag and drop of a block into any other Helix Native or HX Edit window **moves** the block.
- Since performing a drag and drop of a block is essentially the same as a Copy/Paste Block or Move Block operation, the same rules and behaviors apply—please see the preceding section.

 **NOTE:** When dragging a block, if you try to drop it on top of an existing block, you'll see the existing block shift left or right to place your dragged block before or after it. Unlike when using the Copy and Paste commands, it is not supported to *replace* an existing block via drag and drop.

Block Order and Stereo Imaging

Helix Native is a stereo plug-in, with each Signal Flow path carrying two channels of audio. When Helix Native plug-in is inserted on a stereo DAW track and fed a stereo input (or playback of a stereo clip), the left and right audio is processed discretely in stereo within each of the paths, wherever stereo blocks are used within the path. When the track is fed a mono source, the mono signal is split and fed equally to the left and right channels within the path. Whenever a mono block is added within a path (such as an Amp or mono Effects model), both channels of audio are combined and sent out of the block as mono.

Most of the Helix effects models have both mono and stereo versions. A stereo block displays  after its model name in the inspector. The stereo imaging—or how wide your tone appears with stereo monitor speakers or headphones—is highly dependent on the type of blocks you add, and in what order.

Legacy effects models vary in behavior, just as on the classic Line 6 effects from where these models originated.

- Legacy Distortion, Dynamics & Pitch/Synth effects are mono.
- Legacy Modulation & Delay effects vary in that some are mono, some stereo, and some mono-in/stereo-out, where adjusting the effect's Mix parameter can narrow the stereo image that is fed into them. It is best to experiment with these effects and tweak the Mix parameter to achieve the desired stereo output results.
- Legacy Filter and Reverb effects are stereo.

Keep the following in mind when building tones:

- All Amp+Cab, Amp, Preamp, single Cab and IR blocks are mono, so any stereo signal sent into these will be collapsed to mono. As such, it's a good idea to add only mono effects blocks **before** amps and preamps to conserve computer processing resources.
- Adding a mono effects block will collapse any preceding stereo blocks' signal on the same path to mono.

- The Helix Native plug-in's Signal Flow always allows the use of mono or stereo type processing blocks, regardless the type of track on which it is inserted. This allows you to utilize any existing preset and create complex routings within the plug-in Signal Flow (see the routing examples later in this chapter). When inserted on a mono output track, the output at the end of the Helix Native signal chain is summed to mono.
- If you're using Helix Native on an audio track with mono input and output, there is no need to use stereo models at all (except, of course, for models that are only offered as stereo).
- Stereo models use twice as much processing resources as mono models, therefore, it's a good idea to only utilize stereo models when stereo processing is desired.

Moving Blocks & Arranging the Signal Flow

To arrange blocks within a signal path, in addition to using Cut/Copy/Paste (see previous section), you can also click and drag any block left or right within the same or any other path, to *move* it to the desired location. While dragging you'll see an empty block location appear to indicate where you can drop your block, and existing blocks will move to accommodate it.



Dragging a Delay block—an available empty block location appears while dragging

TIP: Holding the Alt (Mac) or Ctrl (Windows) key during drag and drop will **copy** the block - see [“Drag and Drop Blocks” on page 36](#).

To follow are a number of pointers for arranging the Signal Flow in different ways (also see the next section for routing examples, to put these tips to use).

Maximum Block Capacity - Just as on the device being emulated, each Helix Native HC mode offers its own capacity for the max. number of blocks that can be added to a path.

- **Helix or Off HC mode** - Up to 8 blocks can be added to any main path or parallel path, for a total of up to 32 blocks. (However, when in Helix HC mode, you are likely to hit the max. DSP limit before being able to add this many blocks—the Off HC mode has no such max. DSP limit.)
- **HX Stomp HC mode** - Up to 6 blocks total can be added.
- **HX Effects HC mode** - Up to 9 blocks total can be added.

Split Paths - Drag a block down from the main signal path and you'll see a parallel, split path (Path B) appear, with both a Split and Merge block created at each end. To remove the split path, clear or move all blocks out of the parallel path.

Change Split Block to a Path Input Block - (Helix or Off HC mode only) Click and drag a Split block from the main path to the lower, parallel path to convert the Split

block to a separate Input block for the parallel path. Drag the parallel path's Input block back up to the main path to restore it as a Split block. (Or right-click on the Split block or parallel path's Input block and use the **Create Input** or **Restore Split** commands instead of dragging.)

Change Merge Block to a Path Output Block - (All HC modes) Click and drag a Merge block from the main Path to the lower, parallel path to convert the Merge block to a separate Output block for the parallel path. Drag the parallel path's Output block back up to the main path to restore it as a Merge block. (Or right-click on the Merge block or parallel path's Output block and use the **Create Output** or **Restore Merge** commands instead of dragging.)

Split Block Options - When a Split block is selected in the Signal Flow, you can choose from among four types of Split blocks and adjust its balance options using the parameter sliders that appear in the **Edit** tab below.

Input & Output Blocks - A path's Input and Output blocks cannot be moved, but when you select one of these blocks, you'll see options within the Edit panel below.

TIP: Please also see [“Editing Input, Output, Split & Merge Blocks” on page 42](#).

Signal Routing Examples

To follow are a few routing possibilities you can try within the Signal Flow. Also be sure to try some of the “template” factory presets we’ve provided within the setlist for even more configurations.

1 into 2

(All HC modes) Drag a split path's Merge block down to Path B. The Merge block shifts right and a duplicate Output block is created:

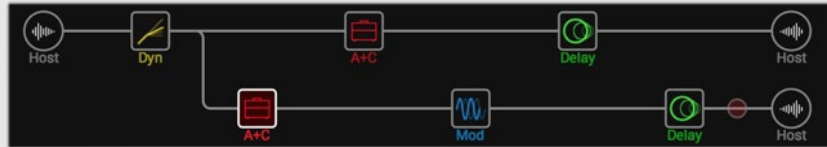

In this example, the input signal is split to stereo Paths A and B (using the default **Split Y** type split block), each with its own Output block. You can now use Path A and B's Output block options to independently pan each left/right as desired.

Parallel Paths

(Helix or Off HC modes) If you start with a split path, you can convert it into two individual, stereo parallel paths, each with its own Input and Output block.

1. Drag the Split block down to Path B (or right-click on the Split block and choose **Create Input**). The Split block shifts left and a duplicate Input block is created.
2. Drag the Merge block down to Path B (or right-click on the Merge block and choose **Create Output**). The Merge block shifts right and a duplicate Output block is created.

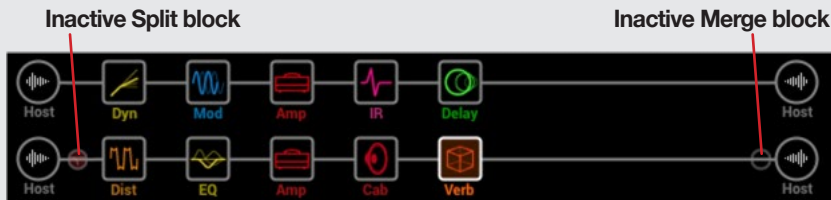

Once converted to Input & Output blocks, the Split and Merge blocks become inactive—you can drag the Split and Merge blocks up to the Path A above (or right-click on the Split or block and choose **Restore Split** or **Restore Merge**) to revert back to a Split Path configuration.

Discrete Stereo Processing with Amps

(Helix or Off HC modes) As mentioned in [“Block Order and Stereo Imaging” on page 36](#), each path within the plug-in is capable of processing discrete left & right audio input on a stereo Audio, Aux or Bus track, provided you're utilizing all stereo blocks on the plug-in's signal paths. But if you're wanting to utilize any Amp or Preamp blocks (which are all mono-output blocks), it is necessary to split the path to allow the left & right audio channels to be processed discretely.

Start with the **AUX: DiscreteDuo** preset provided within the factory **TEMPLATES** setlist. This preset already has all necessary routing configured for discrete stereo using an amp on each path. To follow are the key settings for this Signal Flow.

1. A **Split Y** type block is used with its **Balance A & B** parameters panned hard left and right.
2. The **Merge** block's **Pan A & B** parameters are set hard left and right, respectively, to also keep the two channels' audio discretely separate.
3. The **Path 1 Output** block is fed to **Path 2A**, allowing additional stereo effects blocks to be applied.

Split Y block Path 1A (with mono blocks) Path 1B (with mono blocks) Merge block

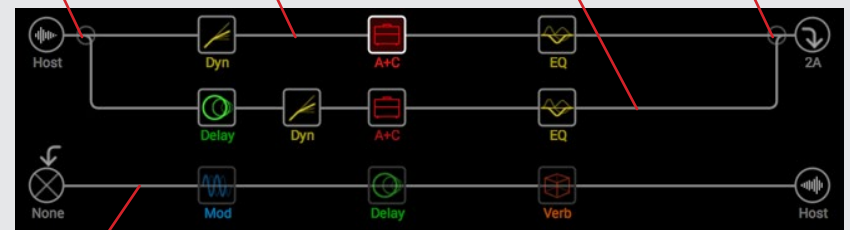

Path 2A (with stereo blocks)

In this configuration, Path 1A of the split path will process only the left signal, and the Path 1B will process only the right signal, allowing you to add *mono* blocks on each of these parallel paths accordingly.

By placing *stereo* blocks on Path 2, it will still retain the left/right channel separation, allowing you to use common effects to save some resources.

Super Serial

(Helix or Off HC modes) A serial path has eight processing block locations. If that's not enough, you can use parallel Path B to create an extended "super serial" path configuration.

1. Drag the Merge block down to Path 1B. A duplicate Output block is created.
2. Drag the Split block all the way to the right, past the last processing block on path 1A.
3. Select the Output block on path 1A and turn Knob 2 (Level) all the way down. That way, you're only hearing Output 1B.



In the illustration above, our signal is processed by the eight blocks on Path 1A and processed further by Delay block (or whatever blocks you wish to add) on Path 1B.

Of course, if this still isn't enough, you could always duplicate the above Signal Flow routing on Path 2 and then route Path 1B's output block to Path 2A for one gigantic serial tone with up to 32 block locations (plug-in processing limit permitting. See ["Computer Processing Management" on page 19](#)):

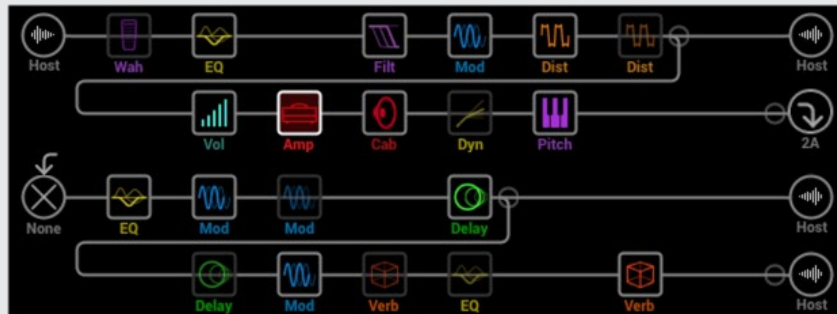

Tips to Optimize Processing Power Usage

The Helix, HX Stomp and HX Effects Hardware Compatibility modes each include a processing limit, matching the DSP limit of their respective hardware devices, in order to maintain preset compatibility with them. The Off HC mode includes no such processing limit, allowing you to effectively add as many blocks, of any type, as will fit on all paths. (Also see ["Computer Processing Management" on page 19](#).)

Of course, your DAW system itself has a finite amount of processing resources, so it is always a good idea to use your plug-ins efficiently. To follow are tips to for keeping the Helix Native processing usage under control.

- Some block types, such as Amps, Cabs, IRs, and Pitch Shifters, use much more of your computer's processing power than others. Not surprisingly, the Amp+Cab block uses the most. EQ, Dynamics and Volume/Pan blocks use relatively little.
- Some models may require more processing power than others of the same category. This is especially true with Amp models.
- Instead of a parallel path with two Amp+Cab blocks or two separate Amps and Cabs, try adding a single Amp block followed by a single Cab > Dual block, or two individual Cab or IR blocks, as in the preceding "1 into 2" example (mixing two different Cabs can provide some substantial variations).
- The stereo version of an effects block will use roughly twice as much processing power as a mono version of the same block. Likewise, the dual version of a cab block will use roughly twice as much processing power as the single version. Therefore, you likely won't want to use stereo versions of blocks in routing configurations where they don't actually provide a stereo output (see ["Block Order and Stereo Imaging" on page 36](#)).
- Some model categories have "Simple" blocks, which utilize less processing power than others.
- The "Legacy" type models often utilize less processing resources than other models of the same effect type.
- When in Helix HC mode, if you hit the processing limit on Path 1, route its Output block to Path 2 for more horsepower. If creating tones with two or more amps and more than a handful of effects, use both paths.

The Edit Tab

The Inspector window's **Edit** tab provides access to all models via its multi-level **Model Browser**, where you can choose from numerous categories of models to make up your tone. This panel also displays all available parameters for the block that is currently selected within the Signal Flow window, providing easy access for editing. Be sure to check out the [“Model Lists”](#) chapter for the full array of models and what they are based on.

Selecting Models

As mentioned in the previous chapter ([page 35](#)), add models to your current preset by selecting the desired empty location on any path within the Signal Flow window and then choose your specific model from the Model Browser. You can also select any existing block within the Signal Flow and change its model this way. (Also note that if you select an Input, Output, Split & Merge block, the Model Browser can also offer options for these block types.)

List/Grid View Toggle Sub-Category Menu

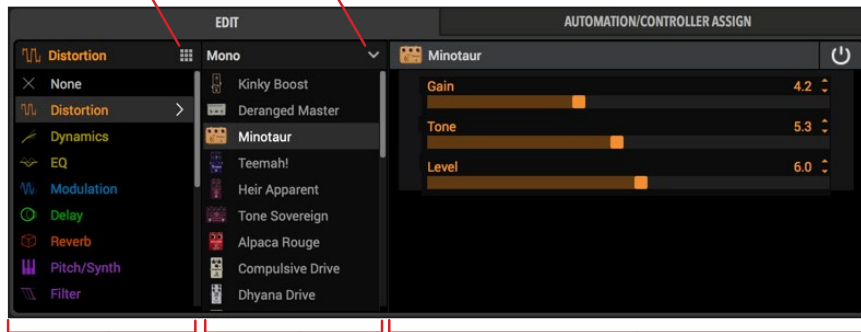

Category List Model List/Grid Parameter Sliders

The Edit tab's Model Browser

Choose the type of block first in the **Category List** at the left and you'll see all of its available models appear in the **Model List**. Note that, once you've selected a Category, you can toggle **List/Grid View Toggle** button to change between a list or grid display of the category's models.

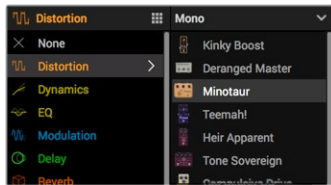

Model List view

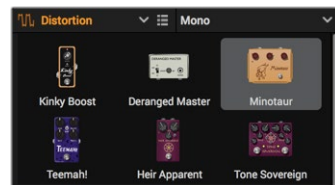

Model Grid view

For block categories that offer it, you'll see a **Sub-Category menu** at the top of the Model List, where you can choose to see Mono, Stereo or Legacy type models. Amp categories offer Guitar & Bass sub-categories, and for Cabs you'll see Single & Dual sub-category options.*

***NOTE:** Amp+Cab, Amp, Preamp and Cab models are not supported when in the HX Effects Hardware Compatibility mode, therefore, you won't see these Categories or Models in the menu when Helix Native is using this mode (see [page 13](#)).

Once you click on any model in the Model List it is instantly active and loaded into the selected Signal Flow location. (You can click on models here to preview them in real-time as your DAW track is playing.) When a model is selected, its editable parameters appear at the right of the Edit panel. If you want to remove an existing block, select it within the Signal Flow and choose the **None** category's **Empty Block** option. Or alternatively, right-click on the block within the Signal Flow and choose the **Clear** command.

Availability of Models within the Model Browser

There are cases where some model types are displayed as “dimmed” and not selectable within the Model Browser. There are limits for how many of some types of models can be inserted within a path and/or within a preset, depending upon the current HC mode in use, as described below.

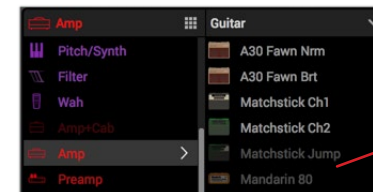

Dimmed models

Unavailable models appear dimmed within the Model Browser

Block Type	Hardware Compatibility Mode			
	Helix	HX Stomp	HX Effects	Off
Amp+Cab, Amp, or Preamp	Up to four, any combination, within a preset (up to two per path)	Up to two, any combination	Amp, Preamp, and Cab blocks not supported	No restrictions
Cab (includes Amp+Cab)	Up to four (two per path; Cab > Dual blocks are considered two)	Up to two	Amp, Preamp, and Cab blocks not supported	No restrictions
Impulse Response	Up to four 1024-point IRs (two per path) or two 2048-point IRs (one per path)	Up to two 1024-point IRs or one 2048-point IR	Up to two 1024-point IRs or one 2048-point IR	No restrictions
Send/Return & Looper	Non-functional*	Non-functional*	Non-functional*	Non-functional*

*Non-functional type blocks remain “disabled” since they are only functional in Helix hardware and, therefore, cannot be added from within the Helix Native Model Browser (see [page 17](#)).

Additionally, as per the computer processing management functionality of Helix Native (when set to any HC mode other than Off, see [page 19](#)), when the current tone approaches its allowable processor usage limit, some models may not be selectable if adding them would result in the tone exceeding the limit. To free up more resources for the current preset, try removing some models, or swapping out models with similar mono or “simple” versions within the same category.

Editing Model Parameters

Once added to your tone, simply click on any block within the Signal Flow to select it and you'll see the model category and type highlighted in the Model Browser, with its parameter sliders available at the right of the Edit tab.

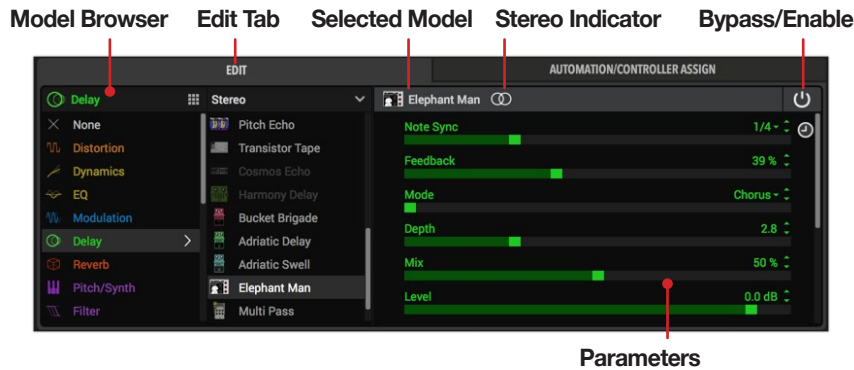

The Inspector Window - Edit Tab

Selected Model, Stereo Indicator- At the top of the parameter pane you'll see the name of the selected model. If the selected model is stereo, the  indicator appears to the right of its name, as pictured above.

Bypass/Enable - For all block types that support it, the Bypass/Enable button at the top right allows you to manually toggle the selected block's processing on or off. Note that you'll see all the block's parameter sliders become “dimmed” to indicate the bypassed state. Alternatively, hover over the block and use Bypass button that appears above the block, or right-click or Ctrl+click to choose the bypass/enable options from the context menu—see [“Adding, Clearing & Bypassing Blocks” on page 35](#).

Adjusting Parameter Sliders - There are several ways to adjust slider values:

- Click on any slider's “handle” and drag to the desired value.
- Click on the desired range location within a slider's path and it will jump to the clicked value.
- While hovering your mouse cursor over any slider's path, use your mouse wheel to adjust it. (Note that hovering over the scroll bar at the right also allows you to use the mouse wheel to scroll vertically when there are more parameters.)
- Click the up/down arrow buttons at the right for incremental adjustments. If a down arrow is displayed at the right, click on it to expand a menu of selectable options.

Resetting Sliders - If you're not happy with your slider adjustment, use Cmd+click (Mac) or Ctrl+click (PC) on a slider to reset it to its initial default value.

Type in a Precise Value - Double-click anywhere on a slider's path, or on its value, to manually type in a precise numerical value.

Configuring a Parameter for Host DAW Automation - Right-click on a slider to display the menu of automation controllers, which allow the host DAW application to access the parameter for its automation features—see [“The Automation/Controller Assign Tab” on page 43](#) for details.

Accessing All Parameters - Note that some model types, such as amps and complex effects, may have more sliders and controls than you can see all at once in the Edit tab. Click and drag the vertical scroll bar at the right to access all parameters (or use your mouse wheel when hovering your mouse cursor over the vertical scroll bar). You can also resize the entire plug-in window as desired by dragging its bottom right corner.

Note Sync

Most modulation and delay effects models offer a **Note Sync** option, allowing the modulation rate or delay repeat time to follow the plug-in's main tempo value. For models that offer it, you can click the Note Sync button within the Edit tab to toggle the feature on/off. When active (the Note Sync button is lit), the parameter will change to offer note division values, as shown below.

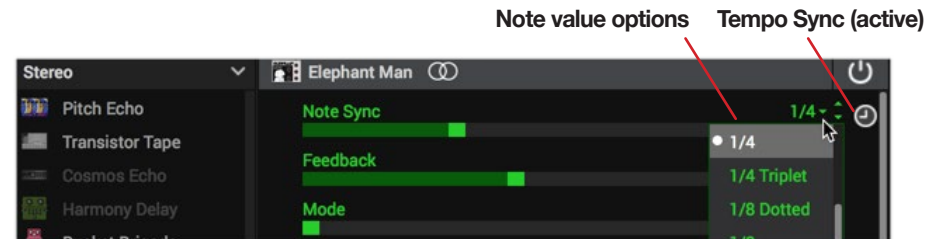

A Delay block's Delay Time parameter configured for Note Sync

Set the plug-in's main Tempo Controls at the top right of the plug-in window to **Host Sync** mode for the individual, active Note Sync parameters to follow your host project's timeline tempo (also see [“Editing the Tempo” on page 30](#)).

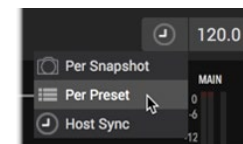

Setting the plug-in to Host Sync tempo mode

Otherwise, when the main Tempo Controls option is set to **Per Preset** or **Per Snapshot**, the parameters' Note Sync follows the editable tempo value that is displayed in the numerical tempo field at the top right of the plug-in.

Editing Input, Output, Split & Merge Blocks

Just as with Amp & Effects blocks, you can click on these block types within any Signal Flow path and access their options in the Edit tab.

Input Block Options:

- The Input block for any path (except Path 1A) is able to be set to receive input from the **Host** or **None**. If you have configured the Output block of a preceding path to feed into the current path, then you may wish to set the current path's Input block to None so that it does not *also* receive input audio from your Host DAW track.
- All Host Input blocks include a built-in Noise Gate, and you'll find the Gate's On/Off and parameter sliders here as well.

Output Block Options:

- All Output blocks offer **Pan** and **Level** sliders within the Edit Tab.
- (Helix or Off HC modes) Path 1's Output block offers options to feed the path's output to **Host**, or into any existing Input block of Path 2. (If you've created a separate Path 1B, its output block offers these options as well).* Path 2's Output block is always routed to **Host**.

 ***TIP:** See [page 37](#) for info about creating different possible path routing configurations using these Output block options.

Split Block Options - If your preset includes a Split path, click directly on the point of the main path where the signal divides to select the Split block and you'll see options for choosing between four different Split block types, as described below. Note that there is also a Bypass switch for Split blocks which, when bypassed, results in the block feeding an equal signal to each parallel path.

- **Split Y:** By default, a Split > Y appears any time parallel Path B is created. Use the **Balance A** and **Balance B** parameters to adjust the left/right stereo balance of each path, respectively
- **Split A/B:** Use the **Route To** parameter to determine the total amount of signal fed to Path A versus Path B.
- **Split Crossover:** Splits the audio content so that treble frequencies are sent to Path A and bass frequencies are sent to Path B (or the path routing is reversed when **Reverse** is **On**). Use the **Frequency** parameter to set the center frequency; Any signal above this frequency is sent to Path A, and any signal below this frequency is sent to Path B.
- **Split Dynamic:** Similar to a crossover, except the audio content above the audio **Threshold** is sent to Path A, and the content below the audio Threshold is sent to Path B (or the path routing is reversed when **Reverse** is **On**). The **Fade** parameter determines how steep the cutoff curve is between the two paths—higher values result in a smoother transition.

Merge Block Options - If your preset includes a Split path, click directly on the point of the main path where the signal returns to select the Merge block and you'll see several mixer options for blending the two paths' signals.

 **TIP:** Split and Merge blocks can optionally be dragged down from Path A to Path B to create individual parallel paths and other routing configurations. See [page 37](#).

Editing Send, Return, FX Loop & Looper Blocks

These block types are supported only by Helix and HX hardware devices, therefore, you'll only see them within Helix Native when importing a preset that was exported from a Helix or HX device. When included within a Helix Native tone, they are displayed with a slashed circle icon on the block to indicate it as a “non-functional” block, as shown below. Please also see [“Hardware Blocks \(Send, Return, FX Loop & Looper\)” on page 17](#).



“Non-functional” blocks within Helix Native's Signal Flow

 **NOTE:** If an existing Send, Return or FX Loop block is toggled as “active” via its Bypass switch, it can reduce or fully mute the path's audio signal, depending on the block's **Mix** or **Dry Thru** parameter settings. To ensure these block types are not affecting the plug-in's signal path, simply toggle the block as bypassed.

You can still move & clear these blocks within the Signal Flow, and edit the parameters of these blocks within the Edit tab. Your edits are retained within your exported presets for use on Helix/HX devices—see [“Preset Compatibility with Helix and HX Devices” on page 13](#).

The Automation/Controller Assign Tab

The Inspector window's **Automation/Controller Assign** tabbed panel is where you can create, edit and reference all your automation controller assignments for the current plug-in instance. This panel offers two sections: the **Assignment List** at the left where all current assignments are shown, and the **Inspector** at the right where you can create new automation assignments and access additional options for existing assignments.

NOTE: Actions performed within the Automation/Controller tab are not tracked by Undo / Redo. Please also see [“Undo and Redo” on page 28](#).

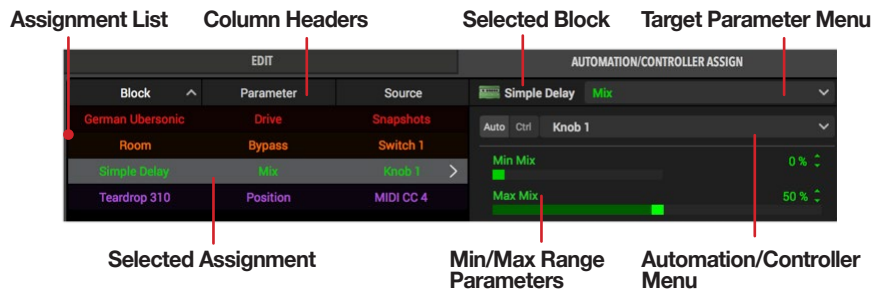

The Automation/Controller Assign tab

The features within this tab are described below. Also see the following sections for specific steps on creating different assignment types.

- **Assignment List** - The 3-column pane at the left displays all existing bypass, automation, and controller assignments for the current preset, listing the parent **Block**, **Parameter** of the assignment, and the controller **Source** (the type of assignment it is—a Snapshot, Knob or Switch, or MIDI CC). When you select the assignment in this list (which is then displayed as highlighted), its editable settings appear in the Inspector pane to the right.
- **Target Parameter Menu** - When a block is selected within the Signal Flow, or when an assignment is selected within the Assignment List at the left, this menu offers selection of any available parameter for that block. Here is where you can select the specific parameter for which you want to create an assignment, or to edit the settings of the parameter's existing assignment.
- **Automation/Controller Menu** - This menu is where you choose the type of controller source for the parameter currently selected in the Target Parameter Menu. Use the **Auto** button at the left of this menu to choose an automation Knob or Switch type controller source, or use the **Ctrl** button to choose a snapshot or MIDI CC type controller source. Once a controller source is selected, the assignment is created, and you'll see additional sliders appear in the space below this menu (such as the Min/Max Range sliders appear for the Simple Delay - Mix - Knob 1 automation assignment in the screenshot above).

Hardware Controller Assignments within Helix Native

If you are importing a Helix or HX hardware preset that was exported from HX Edit, it is possible the preset may include hardware-specific bypass and controller assignments (such as EXP Pedal or Footswitch controller assignments). As covered in [“Preset Compatibility with Helix and HX Devices” on page 13](#), hardware bypass and controller assignments are not functional within Helix Native, but you can configure Helix Native to display them in its Automation/Controller - Assignment List for reference. To do so, choose the **Show assignments** option Preferences window > Hardware Compatibility tab > Show hardware bypass/controller assignments menu (by default, this option is set to Hide assignments).

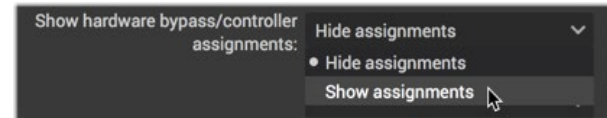

The Preferences - Show hardware bypass/controller assignments menu

When shown, these assignments appear with a hardware icon at left and dimmed (see below), since they are not editable in Helix Native, but you can Clear them via the Clear Assignment commands within the assignment's right-click/Ctrl+click menu.



Hardware bypass/controller assignments appear within the Assignments List

About Plug-in Parameter Automation

Helix Native supports your host DAW application's features to read, write and edit parameter automation, where the DAW can control the plug-in's parameter values over time using editable track envelopes. Helix Native takes this concept even further and not only allows for practically any block's parameters to be automated, but also allows automating the loading of any of the current preset's snapshots, which effectively provides simultaneous switching of numerous Helix Native parameters in one action!

Most DAWs additionally allow you to record parameter automation in real-time, where you enter an automation “write” mode and changes to the selected plug-in parameters are recorded and displayed on the track as adjustable envelopes. This allows all these parameter changes to be played back (using the host's track “read” mode option) and incorporated into your project's mix-down.

Host DAW applications typically allow you to access the list of automatable parameters for a plug-in by way of an automation parameter menu, specific to the audio or aux track where you have inserted the plug-in. Each host DAW software offers parameter automation options slightly differently, so it is recommended that you consult your host software's documentation for its specific instructions and parameter automation capabilities.

Controller Assignment for Automation

Since Helix Native can potentially include numerous parameters (depending on how many Amp & Effects blocks you add within your tone), it utilizes a set of assignable controllers that allow you to map whichever sliders and switches you desire to automate. To follow are what will appear as “automatable” Helix Native parameters within your host DAW application's plug-in automation menus.

- **Knob 1-16 Controllers** - Allow you to assign “variable” type controls—for example, the Mix slider of a delay, or the Drive slider of an amp.
- **Switch 1-16 Controllers** - Allow you to assign “Off/On” switches, such as the Bypass switch for any block.
- **Snapshot Index Controller** - Allows you to automate the loading of any of the current tone's snapshots.
- **Additional “Fixed” Controllers** - These Helix Native global parameters are already mapped and require no automation controller assignment: **Master Input Level**, **Master Output Level**, and **Master Bypass**. (Note that some host DAW applications also offer their own “fixed controllers” within their automation menus that are also usable with Helix Native plug-in, such as a Wet/Dry Balance or their own plug-in bypass.)

Creating an Automation Controller Assignment

Before you'll be able to utilize your DAW host's track automation for a Helix Native parameter, it is necessary to first assign the desired parameter to an automation “Knob” or “Switch” controller. This is performed as follows.

Automating a Variable (Slider) Parameter:

1. Click on the block within the Signal Flow which contains the model and parameter that you wish to automate. For this example, we'll create a controller assignment to automate the Mix slider of the Simple Delay model.
2. In the Automation/Controller Assign tab, you'll see that the Simple Delay block name is displayed at the top, indicating that it is the selected block. Click on the **Target Parameter** menu to see all of the Simple Delay's parameters—select the **Mix** parameter.

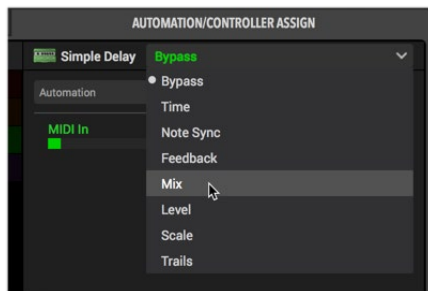

Selecting a Delay's Mix as the target parameter for automation assignment

3. Once a target parameter is selected, click on the **Auto** button at the left of the **Automation/Controller** menu, then select the desired “Knob” controller from the menu to which you want to assign your selected target parameter. We will select **Knob 1**. (You can alternatively assign a slider to one of the Switch automation controllers to allow the parameter to be automated strictly between two defined values—see the Tip at the end of this example.)

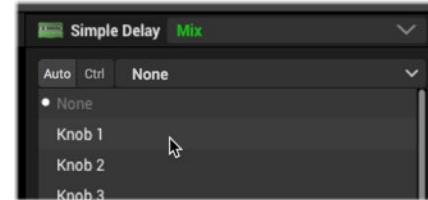

Selecting a Knob automation controller for a target parameter

Once selected, you'll also see your assigned block and parameter name displayed to the right of the Knob controller within this menu for a handy reference, as shown here:

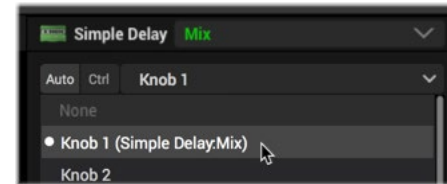

The existing automation controller assignment's block and parameter name is displayed

TIP: As an alternative to steps 2 & 3, you can right-click directly on the Simple Delay's Mix slider within the Edit tab, choose Automation Assign and the desired Knob controller from the menu.

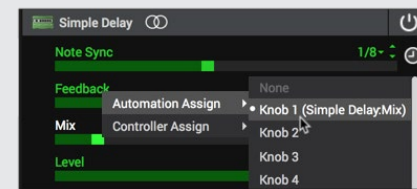

Creating an automation assignment from a slider's context menu in the Edit tab

Once created, you'll also see your assigned block and parameter name displayed to the right of the Knob or Switch controller within this menu, as shown above.

NOTE: Only one parameter can be assigned to any one Knob (or Switch) automation controller at a time—choosing a controller with an existing assignment will *replace* the existing assignment. Or, you can choose **None** to remove an existing assignment.

- Once the assignment is created, you'll see it appear in the Assignments List at the left. When selected in this list, you can edit its assignment settings at the right of the tab—see [“Editing Options for an Existing Automation Controller Assignment” on page 46](#). You'll also see an automation assignment knob indicator icon (or switch icon, depending on which type of assignment you created) displayed for the parameter's slider within the Edit tab, which includes the knob number to which it is now assigned:



An automation assignment indicator for “Knob 1” appears at the left of the assigned slider

TIP: Click on the little knob automation assignment indicator at the left of the slider to jump to the Automation/Controller tab, where the assignment is selected and its editable options displayed.

- Now access your host DAW app track's automation parameter menu and select the Helix Native - Knob 1 to configure it for host automation.
- You should be able to see an envelope line for the “Knob 1” parameter for the track (your host app may require that you toggle an option to display it). Adding edit points and adjusting this envelope will now directly adjust the assigned Mix slider of the Simple Delay.

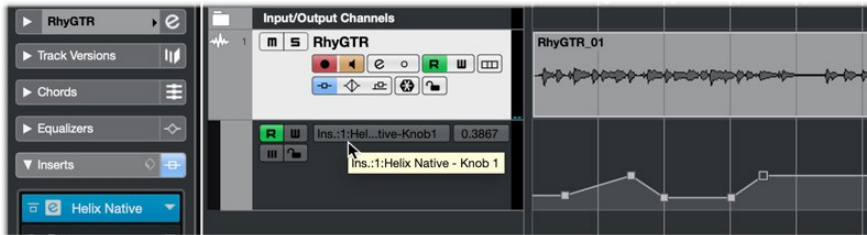

Cubase Pro with Helix Native “Knob 1” automated on an audio track

You can repeat these steps, choosing other “Knob” controllers, to create additional automation assignments for the Simple Delay (or any other selected block within the Signal Flow), if you wish to automate more parameters for this Helix Native plug-in instance.

TIP: Alternatively, in step 3 you can choose one of the **Switch 1-16** automation controllers, which configures the parameter to be automated strictly between two specific values. You can define the two values within the Automation/Controller Assign tab using the assignment's **Min & Max** value options—see [“Editing Options for an Existing Automation Controller Assignment” on page 46](#).

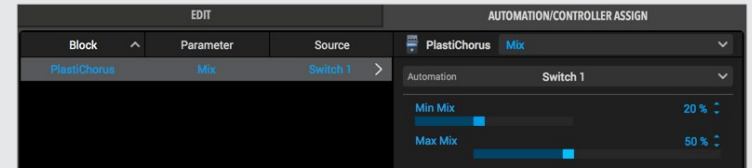

As shown in the example above, a variable Mix parameter slider is assigned to a Switch automation controller, with its Min and Max Mix values set for 20% and 50%. These are the two specific values to which the host track automation will be toggled between.

Automating an Off/On Switch Parameter:

The Switch 1-16 automation controllers are useful for when you wish to automate a parameter between two specific values. Most commonly this would be a block's Bypass Off/On, but you can automate other parameters in the same way, such as the Speed - Fast/Slow switch of a rotary speaker model. For the following example, we'll configure the bypass of a Simple EQ block.

- Add a Simple EQ block to your Signal Flow and click on it to select the block.
- In the Automation/Controller Assign tab, you'll see that the Simple EQ block name is displayed at the top, indicating that it is the selected block. Click on the **Target Parameter** menu to see all of the EQ's parameters—select the **Bypass** parameter (if not already selected as the default).

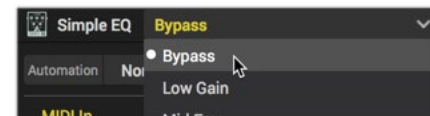

Selecting Bypass as the target parameter for automation assignment

- Once the Bypass target parameter is selected, click on the **Automation Controller** menu that appears and select the Switch controller to which you want to assign your selected target parameter. We will select **Switch 1**.

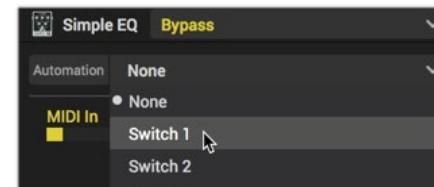

Selecting a Switch automation controller for a target parameter

Once selected, you'll also see your assigned block and parameter name displayed to the right of the Switch controller within this menu for a handy reference, as shown here:

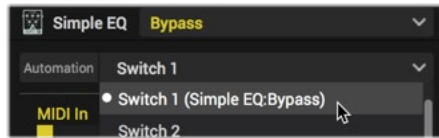

The existing switch controller assignment's block and parameter name is displayed

TIP: As an alternative to steps 2 & 3 for assigning block bypass, you can right-click directly on the EQ block within the Signal Flow, or right-click on the model's Bypass button within the Inspector pane - Edit tab panel, and choose the desired Switch controller from the **Automation Bypass** menu.

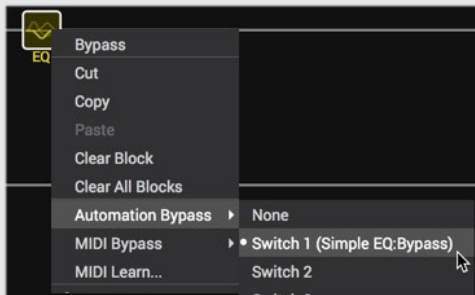

Creating an automation bypass assignment from a block's context menu

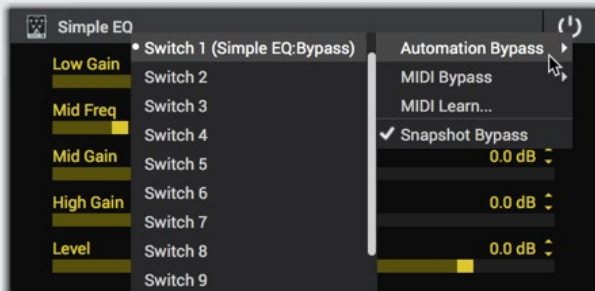

Creating an automation bypass assignment from the Edit tab - Bypass button's context menu

Once selected, you'll also see your assigned block and parameter name displayed to the right of the Switch controller within this menu, as shown above (Simple EQ: Bypass) .

NOTE: Only one parameter can be assigned to any one Switch (or Knob) automation controller at a time—choosing a controller with an existing assignment will *replace* the existing assignment. Or, you can choose **None** to remove an existing assignment.

- Once the assignment is created, you'll see it appear in the Assignments List at the left. When you select an existing assignment in this list, you can edit its settings at the right of the tab—also see [“Editing Options for an Existing Automation Controller Assignment” on page 46.](#)
- Now access your host DAW app track's automation parameter menu and select the Helix Native - Switch 1 parameter to configure it for host automation.
- You should be able to see a “Switch 1” parameter envelope line for the track (your host app may require that you toggle an option to display it). Adding edit points and adjusting this envelope will now directly toggle the bypass state of the assigned Simple EQ block. Note that, since this is a “switch” type parameter, its track envelope will only create edit points as “off” (the Minimum, 0% value) or “on” (the Maximum, 100% value).



Reaper 5 with Helix Native “Switch 1” automated on an audio track

You can repeat these steps, choosing other “Switch” controllers, to create additional automation assignments for the Simple EQ (or any other selected block within the Signal Flow), if you wish to automate more parameters for this Helix Native plug-in instance.

TIP: You can also utilize a Switch automation controller for an automation assignment to a “variable” Helix Native parameter, such as any model's slider parameter, allowing you to define two specific parameter values to toggle between when automating the Switch's “Off/On” states—see [“Automating a Variable \(Slider\) Parameter:” on page 44.](#)

Editing Options for an Existing Automation Controller Assignment

Once you've created one or more automation controller assignments, they are displayed in the Assignment List at the left of the Automation/Controller Assign tab. This list makes it easy to reference all your automated parameters and edit their available options. The Assignment List includes 3 columns:

- Block** - Displays the name of the parent block which includes the assigned parameter.
- Parameter** - Displays the name of the assigned parameter.

- **Source** - Displays the automation controller source (Knob 1-16 or Switch 1-16) to which the parameter is assigned.

TIP: Note that you can click on these column titles at the top of the list to sort the list by Block, Parameter or Source, ascending or descending.

When you click on any assignment within the list, you'll see the assignment's editable options appear at the right of the Automation/Controller Assign tab. Most variable type parameters offer **Minimum Value / Maximum Value** sliders which allow you to customize the automated values.

If the Automation Assignment Source is a Knob Controller - The Min & Max values define the range for which the parameter can be adjusted, allowing you to limit the range, if desired. For example, if you want an amp's Drive parameter to automate strictly between the value range of 3.0 to 7.5, set these sliders accordingly, as shown below.

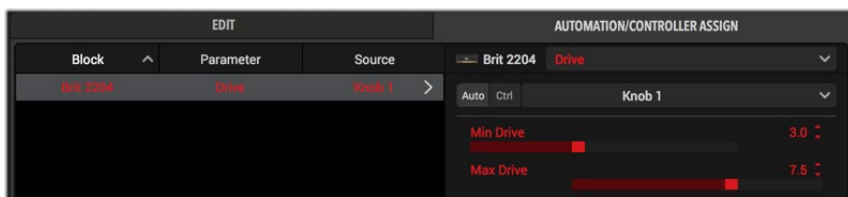

An Amp - Drive “Knob” automation assignment with its Min & Max (range) values defined

NOTE: For automation assignments, (unlike with MIDI assignments) the Min and Max values cannot be inverted.

If the Automation Assignment Source is a Switch Controller - The Min & Max values define the “Off” and “On” values to which the parameter can set, allowing you automate switching between these values. For example, if you want an amp's Drive parameter to automate strictly to *either* 4.0 or 8.5, set these sliders accordingly, as shown in the following image.

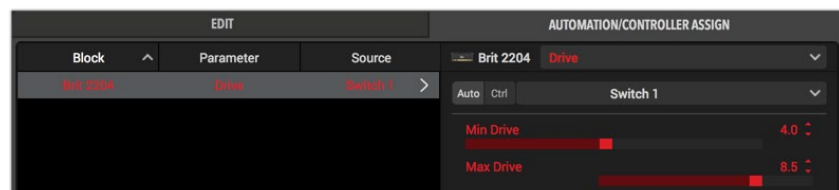

An Amp - Drive “Switch” automation assignment with its Min & Max (Off/On) values defined

TIP: Some DAW hosts also offer additional on-screen controls to provide easy access to track and plug-in parameters, such as the “Smart Controls” in Logic Pro or the “Quick Controls” in Cubase Pro. Typically these types of DAW controls can be set to the Helix Native Knob 1-16 or Switch 1-16 Automation Controllers, for which you'd want to follow the preceding steps to assign your preferred Helix Native parameter to the respective automation controller.

Removing or Replacing an Existing Automation Controller Assignment

To Remove an Existing Automation Controller Assignment - Select the assignment within the Assignment List and choose the **None** option from the Automation Assignment menu.

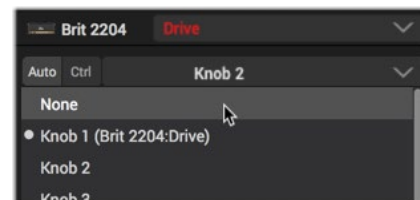

Select None to remove an existing assignment

To Replace an Existing Automation Controller Assignment - Select the existing assignment within the Assignments List and choose a different Knob or Switch controller from the Automation Controller menu. This *removes* the existing controller and applies the newly selected Knob or Switch automation controller to the parameter.* You can then choose this newly assigned Knob or Switch controller from your DAW track's parameter automation menu to automate it.

***NOTE:** In the case where you have written automation for an existing Helix Native assignment and performed the above replace action, the automation envelope in your DAW track will be left “orphaned,” since the Knob or Switch automation controller it was configured to automate no longer references any actual Helix Native parameter. If you assign another parameter to this automated Knob or Switch controller, the track automation envelope will then control the newly assigned parameter—or, you may wish to delete the unused automation envelope from your host project.

To Re-assign an Existing Automation Controller Assignment to a New Parameter - If you choose a new, unassigned block parameter in the Automation menu, and then select a Knob or Switch from the Controller menu that is currently assigned to another parameter, this *removes* the controller assignment from the existing parameter and assigns it to the newly selected parameter. (Any Knob or Switch automation controller can only be assigned to one parameter at a time.)

Automation Assignment Preservation when Changing Models

You may wonder, once you've configured one or more parameters of a particular Amp or FX block with automation assignments, what happens to these assignments if you want to then change the model for this block in your current tone? For just this situation, Helix Native incorporates an automatic “preservation” for automation assignments, which can intelligently re-assign the automation assignments when the new model offers similar parameters.

NOTE: MIDI CC assignments are similarly preserved when changing the block's model.

For assignments to be preserved, the assigned parameters of the newly selected model need to be similar in type and in scale. For example, if you've configured the Drive slider of the Amp+Cab model to be automated by the Knob 1 automation controller, you can then select most any other Amp+Cab, Amp or Preamp model for the block and the Knob 1 controller will automatically re-assign itself to the Drive slider of the new model. Likewise, if you have a Delay's Mix parameter automated, the Mix parameter assignment will typically be preserved for the Mix parameter of most any other type of FX model that includes a Mix slider.

For the cases where automation assignments cannot be preserved automatically, (e.g., when a block's model is changed to one with a very different set of parameters) any existing track envelope with written or edited automation will be left in an "orphaned" state on your DAW track. But you can manually re-assign the automation controller, as covered in the previous section.

Automating Snapshot Changes

As covered on [page 31](#), the Snapshot feature allows you to store a number of settings, such as block bypass, parameter values, tempo values and more, and then recall all snapshot-assigned settings simply by loading the respective snapshot via the plug-in's Snapshots menu. For even more flexibility, Helix Native also allows you to automate the loading of snapshots in real-time using your host DAW application's automation features! Use the following steps to configure a snapshot automation assignment.

1. Access your host DAW app track's automation parameter menu and select the **Helix Native - Snapshot Index** option.



Selecting the Snapshot Index automation option in a Logic Pro track's automation menu

2. You should be able to see a "Snapshot Index" automation envelope line added for the track (your host app may require that you toggle an option to display it). Adding edit points and adjusting this envelope allows you to choose the Snapshot index number that you wish to be loaded over the specified time duration.



The editable Snapshot Index envelope line displayed on the Logic track

Feel free to continue to add, edit or remove the specific items you have included within each of your snapshots. This automation feature simply loads whichever snapshot you set it to load, allowing you to continue to customize snapshots' contents as desired.

Writing Parameter Automation

Most host DAW apps also provide several "Read/Write" modes for parameter automation, which typically appear as a set of options on the track (Off, Read, Write, Latch, Touch, etc.).



The track automation Read & Write mode options in Pro Tools

When set to Read (typically the default), the track will actively "play back" the automation envelope settings on the track, and when set to Off it will ignore the automation envelope.

When one of the Write options is set as active on the track, you can then play the track and manually adjust any Helix Native switch or slider within the plug-in's Edit tab that includes an automation controller assignment, and your moves are recorded to the track in real-time. Also, since the Helix Native Snapshots feature has a dedicated automation parameter (Snapshot Index), the loading of snapshots via the Snapshots menu can also be "written" using your host's Write features. Typically you'll see the parameter's envelope in the track edited with the adjustments that you have written, and you can manually drag individual edit points to edit the envelope further as desired once playback is stopped.

Note that once a parameter is assigned to a controller and automated by the above methods, it is no longer then possible to manually make adjustments directly to the parameter's slider or switch within the Helix Native plug-in window, since it then responds only to the written automation envelope values. To edit the settings, either edit the automation envelope, or utilize one of the host's automation Write modes to make the desired parameter value changes.

MIDI Bypass & Controller Assignment

Most parameters and functions within Helix Native can also be controlled remotely via external MIDI control devices or MIDI software applications. For most Helix Native parameters, this is accomplished by creating a MIDI CC bypass or controller assignment, either by utilizing the MIDI Learn functionality or manually, as shown in the following steps.

TIP: If you happen to own a Helix device, it makes an excellent MIDI controller device for your DAW! Check out the “Command Center” chapter within your *Helix Owner's Manual* for details on how to configure the Helix to transmit a variety of MIDI control messages.

Reserved MIDI CCs

As can be referenced in [“Global Reserved MIDI CCs” on page 52](#), several MIDI CCs are reserved or pre-assigned to Helix Native or Helix hardware global functions and, therefore, cannot be used for creating MIDI assignments to other parameters.

If you are using Helix Native with the Hardware Compatibility mode “Off,” all MIDI CCs can be utilized for MIDI assignments, except CC 0, CC 32, and CC 69 (since these are pre-assigned for Helix Native preset and snapshot functions).

NOTE: You’ll need to configure your DAW host application to receive MIDI Control input from your external MIDI controller device or software. These settings are typically found within the DAW application's Preferences. Additionally, it is often necessary to configure your DAW host track routing to so that the external MIDI Controller data is fed directly to your current Helix Native plug-in instance. This often requires the use of a MIDI or Instrument track to receive the MIDI input and then route it to the audio track on which the Helix Native plug-in inserted. Please see your application's documentation for details.

MIDI In: **TIP:** On the plug-in's Status Bar, at the lower right of the main window, you'll see a handy MIDI In indicator light. When Helix Native receives MIDI input, you'll see this light up green—which can be a big help to let you know you have correctly routed your MIDI controller data into the plug-in!

Creating a MIDI Bypass Assignment

For any block type that includes a bypass parameter, a MIDI bypass assignment can be created to allow the block's bypass to be toggled via MIDI CC. You can create a MIDI bypass assignment in Helix Native either by way using the MIDI Learn feature, or manually, as covered in the following steps.

Creating a MIDI Bypass Assignment Using MIDI Learn:

1. Configure your external MIDI controller device (or software) to send your preferred MIDI CC# (other than a “reserved” CC - see [page 52](#)). For best results, configure a CC Toggle type message with two alternating values, where one value is 0-63, and the other 64-127, allowing the bypass to be toggled between its On and Off states.

2. Within the Signal Flow, select the Amp, Effects or Split block for which you want to create the MIDI bypass assignment. We've chosen the Distortion - Compulsive Drive block for this example.
3. Right-click either directly on the Compulsive Drive block, or on the block's Bypass button that appears within the Edit tab, and choose **MIDI Learn**.

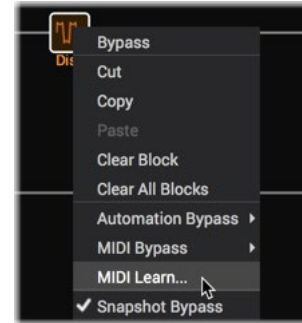

Block right-click menu



Edit tab - Block Bypass button right-click menu

Alternatively, you can click on the MIDI Learn - Arm icon that appears to the right of the MIDI In slider, when the block's bypass parameter is selected within the Automation/Controller tab.

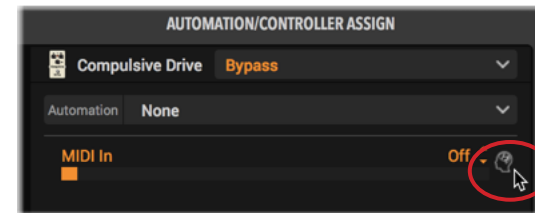

4. This arms the block's bypass parameter, where it “listens” for an incoming MIDI CC message. Within the Signal Flow (and within the Automation/Controller tab), you'll see a little blue icon appear while armed. While a block is armed for MIDI Learn, it listens for a valid MIDI CC type message. All other incoming MIDI message types are temporarily ignored by Helix Native while a block or any parameter is in the MIDI Learn armed state.



The “brain” icon appears flashing/lit while MIDI Learn is armed

TIP: You can arm multiple blocks via their right-click menu's MIDI Learn command and, once you send the MIDI CC from your controller, all will be configured with the same MIDI CC controller assignment in one step!

If you want to disarm MIDI Learn for this block, you can choose **Disable MIDI Learn** from the right-click menu (or by simply left-click on any blinking blue “brain” icon).

- Send the MIDI CC message from your MIDI controller device and you should see the block bypass instantly respond (and the title beneath the block is displayed in brackets, indicating its bypass assignment). You can now access and optionally edit or clear the assignment within the Automation/Controller Assign tab.

Creating a MIDI Bypass Assignment Manually:

- Click on the desired block within the plug-in's Signal Flow to select it. For this example, we've selected a Compulsive Drive Distortion block.
- Go to the plug-in's Automation/Controller Assign tab. If not already selected, choose the Compulsive Drive's **bypass** from the parameter menu at the top right of the tab.
- Click on the menu beneath and choose **MIDI In** as your assignment type. (If the Bypass parameter already includes an existing assignment, choose **None** from the menu to remove it, then choose **MIDI In**.)
- Use the **MIDI In** slider to configure the MIDI CC number to which the block's Bypass parameter will respond—we've select CC 13. Be sure to also configure your external MIDI device to transmit this same MIDI CC number.



Configuring the MIDI In CC number for a MIDI bypass assignment

Once configured as above, when a MIDI CC Toggle message (CC 13 with two alternating values, where one is 0-63, and the other 64-127) is sent to the plug-in, it will switch the block's Bypass parameter.

- Alternatively, you can right-click directly on the desired block within the plug-in's Signal Flow, or select the desired block and right-click on its Bypass button within the top right of the Edit tab, then select MIDI Bypass > MIDI In, and the desired MIDI CC number from the sub-menu to create the MIDI bypass assignment.

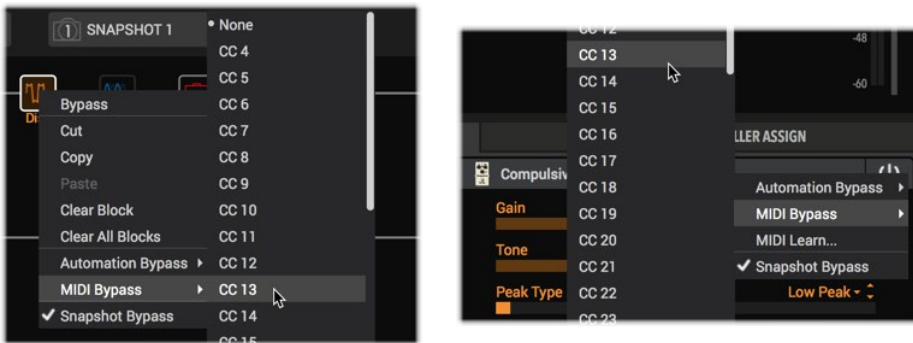

Creating a MIDI bypass assignment from the block in the Signal Flow (left), or from the block's Edit tab-Bypass button (right)

To remove a MIDI bypass assignment, right-click on the assignment within the Assignments List at the left and choose the **Clear** option. Feel free to continue to add, edit or remove MIDI bypass assignments for additional blocks as desired. Be sure to **Save** your tone to retain these assignments within the preset.

Creating a MIDI Controller Assignment

Practically any parameter within Helix Native can be controlled remotely via a MIDI controller device or MIDI software. This can be configured by creating a MIDI controller assignment, either via Helix Native's MIDI Learn function or manually, to allow the parameter to be controlled via MIDI CC. For this example, we'll select a Wah to be controlled via a MIDI expression pedal.

To Create a MIDI Controller Assignment via MIDI Learn:

- Configure your external MIDI controller device pedal/knob (or software) to send whatever MIDI CC# you like (other than a "reserved" CC - see [page 52](#)).
- Click on the Wah block within the plug-in's Signal Flow window to select it.
- Within the Edit tab, right-click directly on the Wah's **Position** slider and choose **Controller Assign > MIDI Learn** from the menu.

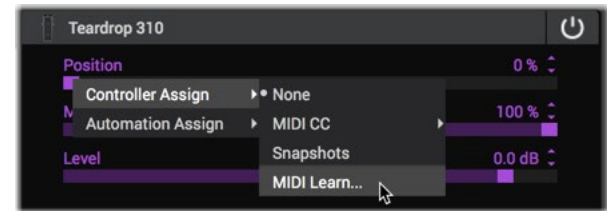

Choosing MIDI Learn from a slider's right-click menu

Alternatively, you can choose the Wah block's **Position** parameter from the menu within the Automation/Controller Assign tab, and click the **MIDI Learn - Arm** button there.

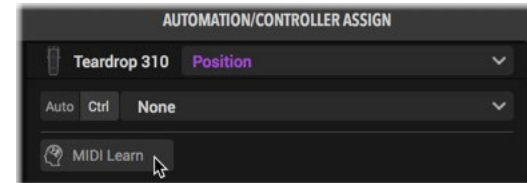

- This arms the parameter, where it "listens" for an incoming MIDI CC message (all other MIDI message types are ignored). Within the Edit tab, and within the Automation/Controller tab, you'll see a little blue flashing/lit icon appear while armed.



The "brain" icon flashes at the left of the Edit tab's slider, and appears lit in the Automation/Controller tab, while MIDI Learn is armed

If you want to disarm the block and cancel the MIDI Learn, you can choose **Disable MIDI Learn** from the right-click menu, or simply left-click on any flashing “brain” icon.

TIP: You can arm multiple parameter sliders via their right-click menus’ MIDI Learn commands—once you send the MIDI CC from your controller, all parameters will be configured with the same MIDI CC controller assignment in one step!

5. Send the MIDI CC message from your MIDI controller device (or software), and you should see the slider instantly respond, as well as display the little MIDI Assignment indicator icon to its left. You can now access and optionally edit or clear the assignment within the Automation/Controller Assign tab.

To Create a MIDI Controller Assignment Manually:

1. Click on the Wah block within the plug-in's Signal Flow window to select it.
2. Within the plug-in's Edit tab, right-click or directly on the Wah's **Position** slider and choose **Controller Assign > MIDI CC**, and then the desired MIDI CC from the sub-menu—we'll choose CC 10—to create a MIDI Controller assignment for the parameter.

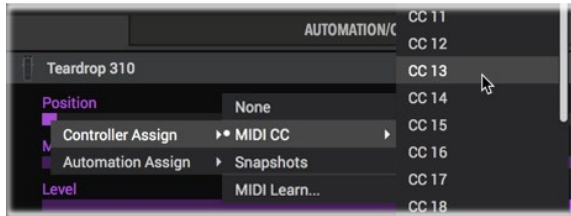

Creating a MIDI Controller assignment for a parameter

3. Go to the plug-in's Automation/Controller Assign tab and you'll see your newly-created Wah MIDI Controller assignment in the list at the left. Click on this assignment to select it and access additional options.

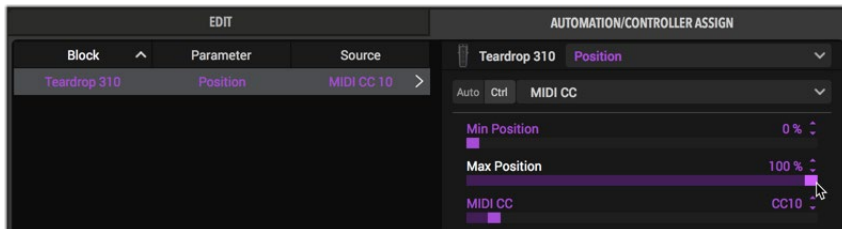

Creating a MIDI Controller assignment for a Wah

4. If desired, you can adjust the Min & Max Position parameters to limit the range of a MIDI CC-assigned parameter. Note that it is possible to make the Min value larger than the Max value, if you want to invert the behavior of the parameter.

Once configured as above, when a MIDI CC 10 message (with values of 0-127) is sent to the plug-in, it will control the Wah block's Position parameter.

5. To remove a MIDI Controller assignment, right-click or Ctrl-click on the assignment within the Assignments List and choose the **Clear** option.
6. Alternatively, you can create a MIDI Controller assignment within the Automation/Controller Assign tab by first selecting the Wah block within the Signal Flow, then, in the Automation/Controller Assign View, choose the desired parameter from the **Parameter** menu (Position in our example), and then set the **MIDI CC** slider to the desired **MIDI CC number** (CC 10 for our example—as seen in the preceding screenshot).

Feel free to continue to add, edit or remove MIDI Controller assignments for additional parameters as desired. Be sure to **Save** your tone to retain these assignments within the preset.

Setlist, Preset, and Snapshot Recall via MIDI

Helix Native also responds to traditional MIDI CC, Bank and Program Change (PC) messages from an external MIDI controller device (or from MIDI software via USB) to allow remote setlist, preset, and/or snapshot loading.

NOTE - AU and AAX Plug-in Formats Only: At this time, remote MIDI control of setlist and preset changes is supported only with the AU (Mac) and Pro Tools AAX (Mac and Windows) Helix Native plug-in formats. It is not supported for the VST2 or VST3 Helix Native plug-in formats on Mac or Windows.

Also note that Setlist and Preset changes performed via MIDI PC/CC messages are not supported by Undo, and will clear the current Undo history - please see [“Undo and Redo” on page 28](#).

Loading a Preset Within the Current Setlist

From your MIDI controller device, send a Program Change message to load the desired preset within the current setlist. The PC message value differs depending on the current Hardware Compatibility mode in Helix Native:

- When in Helix, HX Effects or Off HC mode: use value 0-127 for Preset 01A–32D
- When in HX Stomp HC mode: use value 0-125 for Preset 01A–42C

Loading a Preset Within a Different Setlist

When Helix Native is in the Helix or Off Hardware Compatibility mode, from your MIDI controller device, send a Bank Change CC 32 (LSB) message with a value of 0 (for Setlist 1), 1 (for Setlist 2), etc., followed by a Program Change message (Value 0-127 for Preset 01A–32D) for the desired preset within the setlist. (A CC 32 message will not change the setlist until followed by a PC message to load a preset within the new setlist.)

NOTE: When Helix Native is in HX Effects or HX Stomp HC mode, a Bank Change CC 32 (LSB) message is ignored, since the Preset Library includes only the one, static setlist in these HC modes.

Loading a Snapshot

From your MIDI controller device, send MIDI CC 69 with values as listed below to load the desired snapshot.* (Note that the number of available snapshots per preset differ among Hardware Compatibility modes.)

- When in Helix or Off HC mode: use value 0-7 for Snapshot 1-8
- When in HX Effects HC mode: use value 0-3 for Snapshot 1-4
- When in HX Stomp HC mode: use value 0-2 for Snapshot 1-3
- For any HC mode: use value 8 for the next snapshot, use value 9 for the previous snapshot.

 ***NOTE:** When the Snapshot Index Automation parameter is in use by the host DAW, the Snapshot Index selection will not respond to incoming MIDI CC 69 messages.

 **TIP:** If you happen to own a Helix or HX Effects device, it makes an excellent MIDI Controller device to remotely control Helix Native and your DAW host functions! Additionally, all Helix and HX devices are capable of sending Program Change messages, allowing you to remotely change presets in Helix Native—and can even do so synchronously when changing presets on the device itself.

Note that Helix and HX devices are set to transmit PC messages on device preset changes automatically. If this behavior is not desired you'll want to disable this in the device's Preferences - MIDI settings.

Check out your Helix or HX device's *Owner's Manual* for details on how to configure it to transmit a variety of MIDI control messages.

Global Reserved MIDI CCs

Helix Native has “reserved” specific MIDI CC messages to maintain compatibility with Helix and HX devices. When using Helix Native in the Helix, HX Stomp, or HX Effects HC Modes (see [page 13](#)), these reserved CCs are not available within the Helix Native MIDI In Assignment menus, and not permitted when using MIDI Learn, to create MIDI assignments.*

 ***NOTE:** If you are using Helix Native with the Hardware Compatibility mode “Off,” all MIDI CCs can be utilized for MIDI assignments, *except* CC 0, CC 32, and CC 69.

GLOBAL RESERVED MIDI CCs (Helix, HX Stomp, and HX Effects HC Modes)		
MIDI CC#	Value	Function
0		Reserved for use with Helix hardware assignments
1		
2		
3		
49		
50		
51		
52		
53		
54		
55		
56		
57		
58		
59		
60		
61		
62		
63		
65		
66		
67		
64		
68		
32 (LSB)	0-7	Setlist 1-8 select (Helix or Off HC modes). Note that the setlist change will not occur in Helix Native until the CC32 message is followed by a Program Change (0-127), which then loads the respective setlist and preset.

GLOBAL RESERVED MIDI CCs (Helix, HX Stomp, and HX Effects HC Modes)

MIDI CC#	Value	Function
69	0-7	Snapshot 1-8 select (Helix or Off HC mode)
	0-3	Snapshot 1-4 select (HX Effects HC mode)
	0-2	Snapshot 1-3 select (HX Stomp HC mode)
	8	Next snapshot select
	9	Previous snapshot select
70		Reserved for future use
71		
72		
73		
74		
75		
76		
128	0-63: Oh; 64-127: Nooo	Helix Native achieves self-awareness and starts poking fun of that face you make during the solo

Preferences and About Box

NOTE: Note that some options are available only when Helix Native is set to the **Helix** or **Off** Hardware Compatibility modes, as indicated in the following descriptions (see [“Hardware Compatibility Modes” on page 13](#)).

The Preferences Window

Clicking the **Preferences button** (the little gear icon) at the bottom left of the Helix Native plug-in window opens the Preferences window, where you can configure several settings for Helix Native.

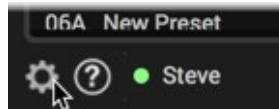

Click the Preferences button to open the Preferences window

The Preferences window consists of a **Restore** button and three tabbed panes of options: **View**, **Presets/IRs**, and **Hardware Compatibility**.

Restore Factory Settings

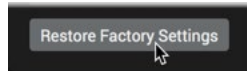

This button at the bottom left of the Preferences window resets all items in all three tabs of the Preferences window back to the initial, factory default settings.

Check for Updates

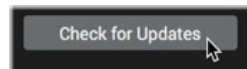

Pressing this button at the bottom of the window will launch your computer's default Browser app and take you directly to the Line 6 Helix Native downloads web page, allowing you to check for and optionally download the latest Helix Native installer version. As noted in the following section, the [“About Box”](#) tells you the version of Helix Native that you are currently using.

Preferences - View Tab

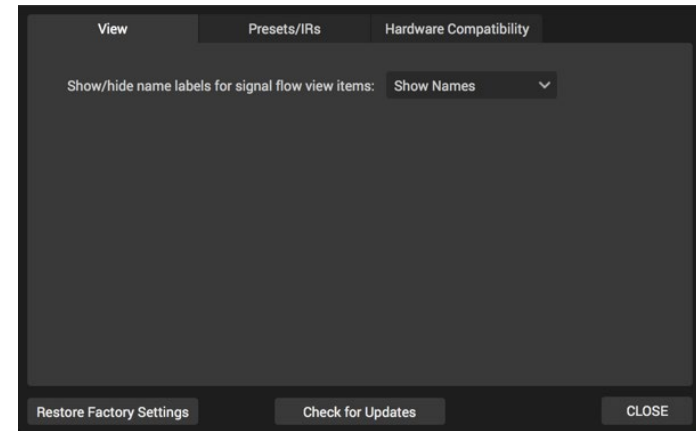

The View tab

This tab includes one option, for configuring how you wish to view the block labels within the Signal Flow.

Show/Hide Block Name Labels - The **Show Names** setting is the factory default. If you prefer to have the Signal Flow window not show labels beneath each block, you can choose **Hide Names** here (see [page 34](#)).

Preferences - Presets/IRs Tab

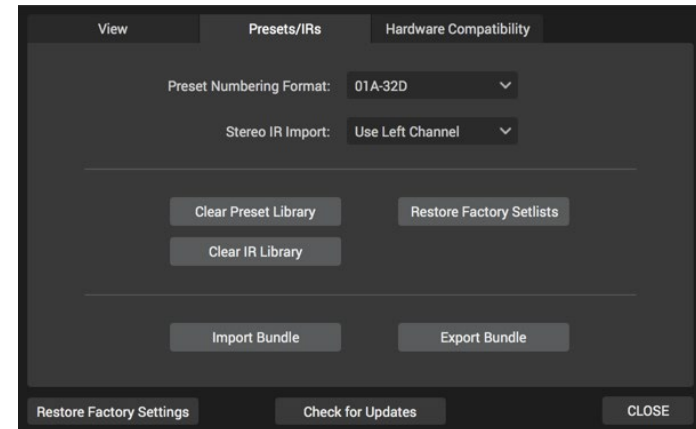

The Presets/IRs tab

This tab includes the following options for the Presets and Impulses Librarian tabs of the plug-in.

Preset Numbering Format - The presets within the Librarian's Presets Panel can be numbered as Bank numbers & letters (as 01A-32D, the factory default setting) or sequentially (as 000-127) within each Setlist, depending on which is more convenient for you.

Stereo IR Import - When a stereo .wav IR file is imported by Helix Native, it is converted to mono. This preference lets you choose whether to take the left channel (the factory default setting) or right channel of the source IR file, or to sum both channels to mono.

Clear & Restore Library Options

This group of buttons within the window offer quick and easy ways to clear out or restore the contents of the Librarian's panels.

IMPORTANT! Be sure to backup your presets and impulses using the Export options within the Librarian panels or Preferences window **before** using these Clear and Restore features - Librarian presets and impulses will be permanently deleted or overwritten, as indicated below.

NOTE: Each of the Helix Native Hardware Compatibility modes includes its own individual Presets Library, containing its own set of factory and custom-created preset files. The **Clear** and **Restore Preset Library** buttons act only upon the Preset Library of the current HC mode in use (see [“Hardware Compatibility Modes” on page 13](#)).

- **Clear Preset Library** - Instantly removes all presets in all setlists within the current HC mode's Preset Library. This replaces all with empty, “new” presets, providing a clean library to create and import presets as desired.
- **Restore Factory Setlists** - The behavior differs depending on the HC mode in use:
 - **When Helix or Off HC mode is in use** - Clears only Setlists 1, 2 & 8 and replaces them with the Factory Setlists 1, 2 & 8 included with the currently installed version of Helix Native.* All of your presets within any other setlists remain unaffected.
 - **When HX Effects or HX Stomp HC mode is in use** - Clears all presets.

***TIP:** Note that when a new version of Helix Native is released, it may include new Factory Presets within some or all HC modes' Preset Libraries. If you already have a previous version of Helix Native installed and install the newer version, you'll need to perform the Restore Factory Setlists function for each HC mode to get the new Factory Presets within your plug-in's Preset Libraries.

- **Clear IR Library** - Instantly removes all IRs from the Impulses Library list. Use the Impulses panel's Import feature to import IR files from your computer's hard drive in whatever order you like. Note that the Helix Native IR Library is one common library shared between HC modes, therefore, clearing this library will clear all IRs for all HC modes.
- **Import & Export Bundle** - (Available only when the **Helix** or **Off** HC mode is in use) A Bundle is a file containing the complete set of all setlists and presets. These buttons allow you to Import a Helix Bundle file from your hard drive, or create and save all the Helix Native Library's setlists and presets in their currently-saved state as a Bundle file to your hard drive. As noted above, this is a great way to easily save a backup of all your Library presets and restore them at any time. Please see [“Importing and Exporting Helix Bundles” on page 23](#) for details.

Preferences - Hardware Compatibility Tab

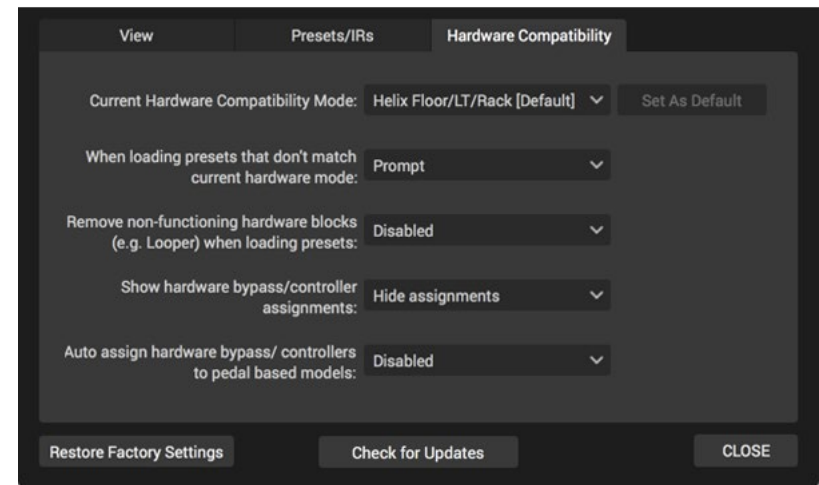

The Hardware Compatibility tab

This tab includes the following options for selecting the current and default Hardware Compatibility mode (HC mode) in Helix Native, and mode behaviors.

Current Hardware Compatibility Mode - This menu allows you to manually choose the current HC mode for this instance of the Helix Native plug-in. The four options are **Off**, **Helix/LT/Rack** (for compatibility with any Helix Floor, LT or Rack device), **HX Effects**, and **HX Stomp**. The **Helix** HC mode is the factory default. Please see [“Hardware Compatibility Modes” on page 13](#) for more info.

Note that changing this mode affects only the *current* plug-in instance, leaving all other existing Helix Native plug-in instances unaffected. The default HC mode for all new Helix Native instances is indicated by the **[Default]** text displayed to the respective mode option within the menu. You can choose which mode you prefer to be the default HC mode for all *future* instances by selecting the desired HC mode in the menu, and then clicking the **Set As Default** button.

When loading a preset that does not match current HC mode - As covered in [“Hardware Compatibility Modes” on page 13](#), when you load a preset within Helix Native that was created with a device or HC mode that differs from the current HC mode in use by your Helix Native plug-in instance, Helix Native has the ability to either automatically change its HC mode to match that of the preset, or to attempt to translate the preset to match the current HC mode. This menu allows you to choose the desired behavior whenever you attempt to load a preset that does not match the current HC mode. This setting is global and will affect the preset loading behavior of all current and future Helix Native instances.

- **Prompt** - A pop up window will prompt you with options to either change the HC mode to match the preset file, or translate the preset to the current HC mode. (This is the factory default setting.)
- **Change to match file** - No prompt is displayed and Helix Native will always switch its HC mode to match that of the preset file.
- **Translate file to current mode** - No prompt is displayed and Helix Native will always attempt to translate the preset to match the current HC mode. (Note that, depending on the content of the preset, it may not be able to be translated, in which case pop up error will alert you and the preset will not be loaded.)

Remove non-functioning hardware blocks when loading presets - Presets exported from Helix/HX hardware can potentially include Send, Return, FX Loop and/or Looper type blocks, all of which are non-functional within Helix Native plug-in (see [page 17](#)). Enabling this option automatically strips out these block types whenever importing Helix hardware Presets, Setlists or Bundles into Helix Native. (**Disabled** is the factory default setting.)

Show hardware bypass/controller assignments - Presets exported from Helix/HX hardware can potentially include hardware-specific bypass and controller assignments, for example, an EXP Pedal for a Wah, or a Footswitch for a block bypass. Setting this option to **Show assignments** allows them to be displayed within Helix Native’s Automation/Controller Assign tab for reference. When displayed, these assignments remain non-editable within Helix Native, but can be cleared. When set to **Hide assignments**, such assignments remain hidden (the default setting). See [“Hardware Controller Assignments within Helix Native” on page 43](#).

Auto assign hardware bypass/controllers to pedal based models - When set to **Enabled**, any time a “pedal based” model (Wah, Volume, or Pitch Wham) is added to your Helix Native Signal Flow, a hardware, EXP pedal controller assignment (plus a toe switch bypass assignment, for a Wah) is automatically created, following the auto assignment behavior of Helix/HX devices. You can enable this to make your Helix Native-created presets more device friendly if you plan on exporting your presets for use on Helix hardware. If you prefer not to have these auto assignments created, keep this as **Disabled** (the default setting).

The About Box and Help Options

At the bottom left of the Helix Native plug-in window, click the ? button to access a menu for the following About Box and Help options.

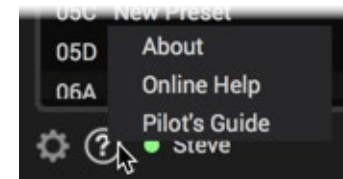

Click the Preferences (gear icon) button to open the Preferences window

About Box

Choose **About** from the menu to display the About Box window, which provides full version and legal information for Helix Native plug-in.

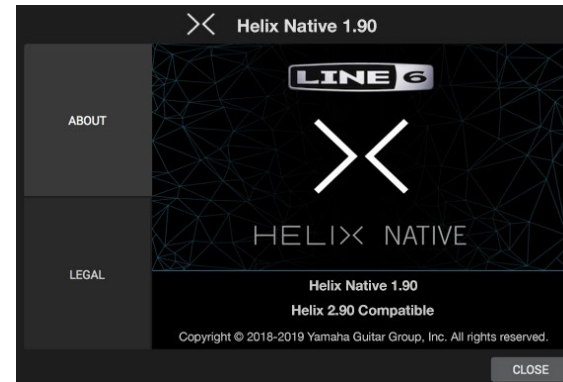

The Helix Native About box screen - About tab selected

Note that the “**Helix 2.xx Compatible**” version number in the lower portion of the About screen informs you which device firmware version is supported if you are to be sharing presets between Helix Native plug-in and your Helix or HX device.

Note that we recommend using the **latest available** versions of HX Edit, Helix Native (where supported by your computer system), and your device firmware for optimal compatibility! Please also see [“Preset Compatibility with Helix and HX Devices” on page 13](#).

Legal Information

Choose the **Legal** tab at the left of the window to display the Legal screen, which lists all the necessary trademark, copyright, and other legally required statements for the Helix Native software.

Online Help

Choose the **Online Help** option from the menu to go directly to the Line 6 Helix Native Support website page within your browser app. Here you can find the Knowledge Base, FAQs, User Forums, and more for Helix Native.

Pilot's Guide

Choose the **Pilot's Guide** option from the menu to open the PDF document you are now reading.

Marketplace & Account Options

Marketplace

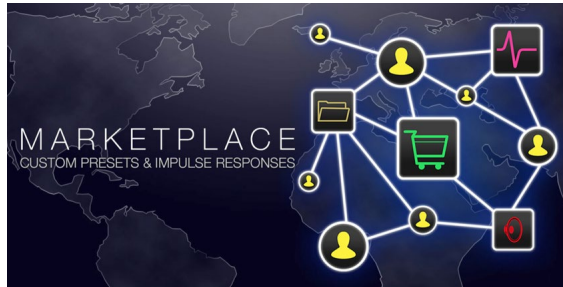

Now open for business is the Line 6 Marketplace online store, where you'll find 3rd-party, premium add-on assets that even further enhance the functionality of Helix Native, as well as Helix and HX hardware devices! As of this writing, professionally crafted presets and IRs are available. Check back often on Marketplace for product news and announcements. As covered within this chapter, you're only a few clicks away from using new Marketplace assets on your system, right from the **My Account** menu in Helix Native.

NOTE: Helix Native version 1.70 (or later) is required for the full functionality of Marketplace premium presets and IRs.

Get Your Marketplace Assets

Access the Line 6 Marketplace website by choosing the **Get More Presets** and **Get More IRs**, commands within the **My Account** menu at the bottom left of the Helix Native plug-in window (or go directly to <https://line6.com/marketplace/>) and sign in to your Line 6 account.* When browsing the Marketplace site, simply choose the desired packs of presets or IRs, add them to your cart, and check out.

***NOTE:** Be sure to sign in to the same Line 6 user account with which you purchased your Helix Native license so that your Marketplace licenses are deposited into the same account!

Once your purchase is complete, your downloadable Marketplace assets are deposited into your Line 6 account, which include your personal license that allows you to import them on your authorized computer system.

To download your purchased assets, click on the **Manage Account** command within the plug-in's **My Account** menu (or go directly to <https://line6.com/account/>), sign in to your account, and select **Helix Marketplace** from the **Hardware & Software** section at the left.

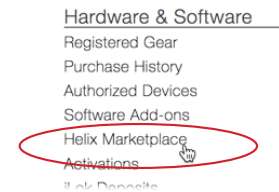

Each Marketplace purchase is downloadable as a “zip” file that you'll need to “unzip” on your local hard drive once downloaded.

Licenses for your purchased assets are automatically added to your Line 6 account, and “synced” the next time you use an instance of Helix Native, as long as you are actively signed in to your Line 6 account from the My Account menu (see [“Account Sign In / Sign Out” on page 59](#)).

Import and Utilize Your Marketplace Assets

Once you've signed in and authorized your computer for use with Helix Native, your computer is also authorized for your premium Marketplace assets—your presets and IRs can then be imported and used just like any other presets and IRs.

Once imported, premium Marketplace presets (individual .hlx preset files, or setlist or bundles files that include them) and/or premium Impulse Responses (.hir files), appear with a golden guitar pick “badge” at their right in the plug-in's librarian lists. (Also see [page 21](#) and [page 24](#) for more about importing presets and IRs.)

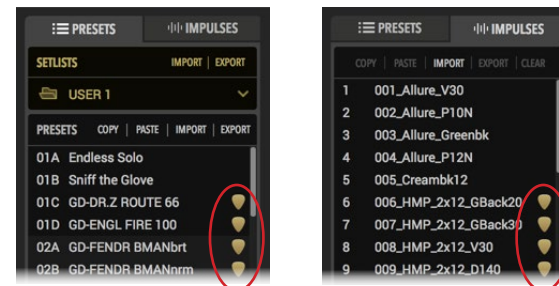

The golden guitar pick badges indicate premium Marketplace Presets and IRs

NOTE: The same Helix Native - Hardware Compatibility mode behaviors apply for the import of any Marketplace purchased presets into the Helix Native Presets Library. If the preset device format does not match the current HC mode, Helix Native will attempt to convert the preset. Please see [“Hardware Compatibility Modes” on page 13](#).

The My Account Menu Options

At the bottom left of the Helix Native plug-in window, you'll see the **My Account** menu and account status indicator. Initially, before you've signed in to your Line 6 account and/or authorized your computer for Marketplace premium assets, you'll see this menu displayed with the **My Account** label.

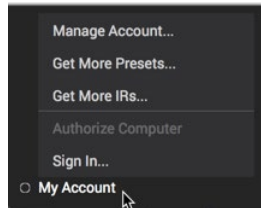

The My Account menu (not signed in or authorized)

Clicking on the **My Account** menu at the bottom left of the Helix Native plug-in window displays options for accessing the Preferences window (see [page 54](#)), signing in & managing your Line 6 account, as well as for accessing Marketplace.*

***NOTE:** Once you've completed the computer authorization, it is not required that your computer have an active Internet connection, nor do you need to be signed in or authorized at all for the Helix Native plug-in itself to be functional. But signing in is necessary to authorize (or deauthorize) your computer to allow the use of Helix Native, including the import and export of premium assets purchased from the online Marketplace.

Account Sign In / Sign Out

Signing in to your Line 6 account from within the Helix Native My Account menu (see above) is necessary to be able to perform the following online processes.

- **To Authorize or Deauthorize your Computer** - Once you've purchased the Helix Native license, it is necessary to Authorize your computer to run it (as covered in the next section).
- **For Authorizing Marketplace Purchases to your Computer** - Whenever you make a new purchase of premium add-ons from Marketplace, you'll need to be signed in to allow Helix Native to initially “sync” with your Line 6 account and authorize the licenses for your newly purchased goodies.

Once your computer is Authorized, you don't otherwise need to be actively signed in, or even have an active Internet connection, to utilize Helix Native plug-in or Marketplace add-ons.* We recommend that you simply remain signed in, as this does not hinder the performance of Helix Native and ensures your licenses are always synced.

***NOTE:** You must be actively signed in at all times if using the Helix Native plug-in in the **15-day Trial Mode**. You must also be signed in for the initial import of any new Marketplace assets, to allow license synchronization—see [“License Synchronization” on page 60](#).

If you are not currently signed in, choose **Sign In** from the My Account menu and enter your Line 6 account user name and password in the Sign In pop-up window. If you have forgotten your sign in credentials or have not already created a Line 6 account, choose the **Forgot my password/username** or **Create a Line 6 account** option within the window. If you are already signed in and wish to sign out, choose the **Sign Out** option from the My Account menu.

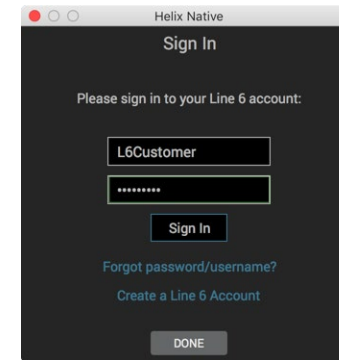

The Sign In pop-up window

Computer Authorization Status Indicator

Once you've signed in and authorized your computer, you'll see the My Account menu label display a green dot and your first name (derived from your Line 6 account), indicating the status of your account sign in and computer authorization (more details about authorization in the following section). When signed out, the menu button displays the “My Account” label, with no colored authorization indicator.

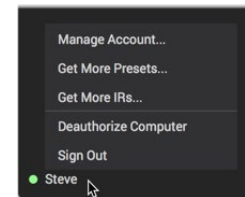

Signed in with computer authorized

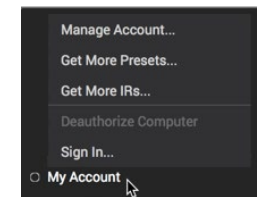

Signed out with computer authorized

Once you've authorized your computer, you can optionally sign out, and your computer remains in the authorized state, allowing you to continue to perform import, export, copy and back up actions with your Marketplace premium assets, even if your Internet connection is not currently active.

Note that you will need an Internet connection to be able to sign in again to access the Deauthorize and Authorize options from the menu, as well as to initially synchronize with your online Line 6 account after making any new Marketplace purchase (see [“License Synchronization”](#)).

Authorize / Deauthorize your Computer

Authorizing your computer allows your purchased (or Trial version) Helix Native license to be run on the computer. It also allows you to utilize premium add-on assets purchased from the Marketplace within Helix Native plug-in.

 **Helix Hardware Owners:** This activation & deactivation within Helix Native globally activates/deactivates your computer for the import, export and use of Marketplace premium assets with the HX Edit application as well—please see the latest [HX Edit Pilot's Guide](#) for details.

It is permitted to authorize a maximum of 4 of your computers concurrently. If you've already authorized 4 computers, you can deauthorize one computer to free up one of these license authorizations—see [“Authorizing your Computer” on page 5](#) for details.

To Deauthorize your computer, first make sure you are signed in to your Line 6 acct. (as covered in the previous section) then complete the following.

If you have purchased & authorized Helix Native - Click on the **Deauthorize Computer** option. The online deauthorization completes momentarily. Helix Native remains installed and selectable within your host DAW app, but the plug-in windows displays only its authorization screen, and will not process audio while deauthorized.

If you are using the 15-day Trial version of Helix Native plug-in - When signed in, you'll see your time remaining for the trial at the bottom of the plug-in window. At any time during your 15-day trial, or once the trial has expired, you can click this time remaining indicator to purchase your software license. Click **Yes** when prompted to do so and you'll be taken to the Line 6 Online Store to make your purchase and be up and running Helix Native plug-in in minutes!

Deauthorizing the Trial License from your Computer - You would likely only want to deauthorize in the event that you want to continue the Helix Native plug-in 15-day trial on a different computer that you own (assuming you have time remaining in your trial). To continue your trial on a different computer, install Helix Native plug-in on the other computer and choose the Trial version.

License Synchronization

Whenever you make a purchase from Marketplace, a license for each product you purchase is deposited into your online Line 6 account. For Helix Native to access your new licenses and effectively “unlock” your purchased assets, it needs to perform a “sync” process with your Line 6 account. **You must have an active Internet connection and be signed in within Helix Native on your next use of the plug-in after your purchase for this license synchronization to occur.**

When you're signed in, this brief sync takes place automatically in Helix Native the next time you insert a plug-in instance, or if already inserted, when you next click on the plug-in window. (Note that it may take up to 5 minutes before a sync occurs for an existing instance of the plug-in.) Once the license sync has completed, an active Internet connection is not required for the use of these Marketplace purchased assets.

Manage Account

Choose this menu option to be taken to the Line 6 **My Account** page (<https://line6.com/account/>), where you can view and update your Line 6 user account—view and manage add-ons and Marketplace purchases, register Line 6 gear, update your personal information, and more.

Model Lists

To follow are the lists of all Effect, Amp, Speaker Cabinet & Microphone models included in Helix Native, as well as the original gear they are based on.* Models, in many cases, include some unique parameters, typically based on the controls found on the original gear we modeled. However, you will also find a set of options that are common to model category types, as described in the sections that follow.

 **TIP:** Most model parameters are able to be configured for automation control by your host DAW software—see [“The Automation/Controller Assign Tab” on page 43](#).

Effects Models

Helix Native includes all the effects models found within the award-winning Line 6 Helix guitar processors. In addition, selected effects from the classic Line 6 DL4™, DM4™, MM4™, and FM4™ stompboxes as well as M13®, M9®, and M5® processors are also included, which are referred to as “Legacy” models.

The following Effects models are found within each of the Helix Native plug-in’s respective block category menus (Distortion, Dynamics, EQ, etc.). Once you’ve selected an effects category in the plug-in’s Model Browser menu, you’ll see up to three effects sub-categories: Mono, Stereo and Legacy. Mono models process in mono, as you’d expect, collapsing the stereo output of any block preceding it to mono. Stereo models process the signal as discrete stereo-in, stereo-out. Legacy type models, just as on earlier Line 6 devices, are a mixed bag and can be either mono, stereo or mono-in/stereo-out. See [“Block Order and Stereo Imaging” on page 36](#) for more info.



Distortion Models		
Model	Subcategories	Based On*
Kinky Boost	Mono, Stereo	Xotic® EP Booster
Deranged Master	Mono, Stereo	Dallas Rangemaster Treble Booster
Minotaur	Mono, Stereo	Klon® Centaur
Teemah!	Mono, Stereo	Paul Cochrane Timmy® Overdrive
Heir Apparent!	Mono, Stereo	Analogman Prince of Tone
Tone Sovereign	Mono, Stereo	Analogman King of Tone
Alpaca Rogue	Mono, Stereo	Way Huge® Red Llama (modded)
Compulsive Drive	Mono, Stereo	Fulltone® OCD
Dhyana Drive	Mono, Stereo	Hermida Zendrive

Distortion Models		
Model	Subcategories	Based On*
Valve Driver	Mono, Stereo	Chandler Tube Driver
Top Secret OD	Mono, Stereo	DOD® OD-250
Scream 808	Mono, Stereo	Ibanez® TS808 Tube Screamer®
Hedgehog D9	Mono, Stereo	MAXON® SD9 Sonic Distortion
Stupor OD	Mono, Stereo	BOSS® SD-1 Overdrive
Deez One Vintage	Mono, Stereo	BOSS® DS-1 Distortion (Made-in-Japan)
Deez One Mod	Mono, Stereo	BOSS® DS-1 Distortion (Keeley modded)
Vermin Dist	Mono, Stereo	Pro Co RAT
KWB	Mono, Stereo	Benadrian Kowloon Walled Bunny Distortion
Legendary Drive	Mono, Stereo	Carvin® VLD1 Legacy Drive (hi gain channel)
Arbitrator Fuzz	Mono, Stereo	Arbiter® FuzzFace®
Triangle Fuzz	Mono, Stereo	Electro-Harmonix® Big Muff Pi®
Industrial Fuzz	Mono, Stereo	Z.Vex Fuzz Factory
Tycoctavia Fuzz	Mono, Stereo	Tycobrahe® Octavia
Wringer Fuzz	Mono, Stereo	Garbage's modded BOSS® FZ-2
Thrifter Fuzz	Mono, Stereo	Line 6 Original
Xenomorph Fuzz	Mono, Stereo	Subdecay Harmonic Antagonizer
Megaphone	Mono, Stereo	Megaphone
Bitcrusher	Mono, Stereo	Line 6 Original
Ampeg Scrambler	Mono, Stereo	Ampeg® Scrambler Bass Overdrive
ZeroAmp Bass DI	Mono, Stereo	Tech 21 SansAmp Bass Driver DI V1
Obsidian 7000	Mono, Stereo	Darkglass® Electronics Microtubes® B7K Ultra
Clawthorn Drive	Mono, Stereo	Wounded Paw Battering Ram
Tube Drive	Legacy	Chandler Tube Driver
Screamer	Legacy	Ibanez® Tube Screamer®
Overdrive	Legacy	DOD® Overdrive/Preamp 250
Classic Dist	Legacy	ProCo RAT
Heavy Dist	Legacy	BOSS® Metal Zone
Colordrive	Legacy	Colorsound® Overdriver
Buzz Saw	Legacy	Maestro® Fuzz Tone

*See [“U.S. Registered Trademarks” on page 70](#). All product names used in this document are trademarks of their respective owners and neither Yamaha Guitar Group nor Line 6 are associated or affiliated with them. These trademarks appear solely to identify products whose tones and sounds were studied by Line 6 during sound model development.

Distortion Models

Model	Subcategories	Based On*
Facial Fuzz	Legacy	Arbiter® Fuzz Face®
Jumbo Fuzz	Legacy	Vox® Tone Bender
Fuzz Pi	Legacy	Electro-Harmonix® Big Muff Pi®
Jet Fuzz	Legacy	Roland® Jet Phaser
L6 Drive	Legacy	Colorsound® Overdriver (modded)
L6 Distortion	Legacy	Line 6 Original
Sub Oct Fuzz	Legacy	PAiA Roctave Divider
Octave Fuzz	Legacy	Tycobrahe® Octavia

Dynamics Models

Model	Subcategories	Based On*
Deluxe Comp	Mono, Stereo	Line 6 Original
Red Squeeze	Mono, Stereo	MXR® Dyna Comp
Kinky Comp	Mono, Stereo	Xotic® SP Compressor
Rochester Comp	Mono, Stereo	Line 6 Original (in conjunction w/ B. Sheehan)
LA Studio Comp	Mono, Stereo	Teletronix® LA-2A®
3-Band Comp	Mono, Stereo	Line 6 Original
Noise Gate	Mono, Stereo	Line 6 Original
Hard Gate	Mono, Stereo	Line 6 Original
Autoswell	Mono, Stereo	Line 6 Original
Tube Comp	Legacy	Teletronix® LA-2A®
Red Comp	Legacy	MXR® Dyna Comp
Blue Comp	Legacy	BOSS® CS-1
Blue Comp Treb	Legacy	BOSS® CS-1 (Treble switch on)
Vetta Comp	Legacy	Line 6 Original
Vetta Juice	Legacy	Line 6 Original
Boost Comp	Legacy	MXR® Micro Amp

EQ Models

Model	Subcategories	Based On*
Simple EQ	Mono, Stereo	Line 6 Original
Low and High Cut	Mono, Stereo	Line 6 Original
Low/High Shelf	Mono, Stereo	Line 6 Original
Parametric	Mono, Stereo	Line 6 Original
Tilt	Mono, Stereo	Line 6 Original
10 Band Graphic	Mono, Stereo	MXR® 10-Band Graphic EQ
Cali Q Graphic	Mono, Stereo	MESA/Boogie® Mark IV Graphic EQ

Modulation Models

Model	Subcategories	Based On*
Optical Trem	Mono, Stereo	Fender® optical tremolo circuit
60s Bias Trem	Mono, Stereo	Vox® AC-15 Tremolo
Tremolo/Autopan	Mono, Stereo	BOSS® PN-2
Harmonic Tremolo	Mono, Stereo	Line 6 Original
Bleat Chop Trem	Mono, Stereo	Lightfoot Labs Goatkeeper
Script Mod Phase	Mono, Stereo	MXR® Phase 90
Pebble Phaser	Mono, Stereo	Electro-Harmonix® Small Stone
Ubiquitous Vibe	Mono, Stereo	Shin-ei Uni-Vibe®
Deluxe Phaser	Mono, Stereo	Line 6 Original
Gray Flanger	Mono, Stereo	MXR® 117 Flanger
Harmonic Flanger	Mono, Stereo	A/DA Flanger
Courtesan Flange	Mono, Stereo	Electro-Harmonix® Deluxe EM
Dynamix Flanger	Mono, Stereo	Line 6 Original
Chorus	Mono, Stereo	Line 6 Original
70s Chorus	Mono, Stereo	BOSS® CE-1
PlastiChorus	Mono, Stereo	Modded Arion SCH-Z chorus
Trinity Chorus	Stereo	Dytronics® Tri-Stereo Chorus
Bubble Vibrato	Mono, Stereo	BOSS® VB-2 Vibrato
Vibe Rotary	Stereo	Fender® Vibratone

*See “U.S. Registered Trademarks” on page 70. All product names used in this document are trademarks of their respective owners and neither Yamaha Guitar Group nor Line 6 are associated or affiliated with them. These trademarks appear solely to identify products whose tones and sounds were studied by Line 6 during sound model development.

Modulation Models		
Model	Subcategories	Based On*
122 Rotary	Stereo	Leslie® 122
145 Rotary	Stereo	Leslie® 145
Double Take	Mono, Stereo	Line 6 Original
AM Ring Mod	Mono, Stereo	Line 6 Original
Pitch Ring Mod	Stereo	Line 6 Original
Pattern Tremolo	Legacy	Line 6 Original
Panner	Legacy	Line 6 Original
Bias Tremolo	Legacy	1960 Vox® AC-15 Tremolo
Opto Tremolo	Legacy	1964 Fender® Deluxe Reverb®
Script Phase	Legacy	MXR® Phase 90 (script logo version)
Panned Phaser	Legacy	Ibanez® Flying Pan
Barberpole	Legacy	Line 6 Original
Dual Phaser	Legacy	Mu-Tron® Bi-Phase
U-Vibe	Legacy	Shin-ei Uni-Vibe®
Phaser	Legacy	MXR® Phase 90
Pitch Vibrato	Legacy	BOSS® VB-2
Dimension	Legacy	Roland® Dimension D
Analog Chorus	Legacy	BOSS® CE-1
Tri Chorus	Legacy	Dytronic® Tri-Stereo Chorus
Analog Flanger	Legacy	MXR® Flanger
Jet Flanger	Legacy	A/DA Flanger
AC Flanger	Legacy	MXR® Flanger
80A Flanger	Legacy	A/DA Flanger
Frequency Shift	Legacy	Line 6 Original
Ring Modulator	Legacy	Line 6 Original
Rotary Drum	Legacy	Fender® Vibratone
Rotary Drum/Horn	Legacy	Leslie® 145

Delay Models		
Model	Subcategories	Based On*
Simple Delay	Mono, Stereo	Line 6 Original
Mod/Chorus Echo	Mono, Stereo	Line 6 Original
Dual Delay	Stereo	Line 6 Original
Multitap 4	Stereo	Line 6 Original
Multitap 6	Stereo	Line 6 Original
Ping Pong	Stereo	Line 6 Original
Sweep Echo	Mono, Stereo	Line 6 Original
Ducked Delay	Mono, Stereo	TC Electronic® 2290
Reverse Delay	Mono, Stereo	Line 6 Original
Vintage Digital	Mono, Stereo	Line 6 Original
Vintage Swell	Mono, Stereo	Line 6 Original
Pitch Echo	Mono, Stereo	Line 6 Original
Transistor Tape	Mono, Stereo	Maestro® Echoplex EP-3
Cosmos Echo	Mono, Stereo	Roland® RE-201 Space Echo
Harmony Delay	Stereo	Line 6 Original
Bucket Brigade	Mono, Stereo	BOSS® DM-2
Adriatic Delay	Mono, Stereo	BOSS® DM-2 w/ Adrian Mod
Adriatic Swell	Mono, Stereo	Line 6 Original
Elephant Man	Mono, Stereo	Electro-Harmonix® Deluxe Memory Man
Multi Pass	Mono, Stereo	Line 6 Original
Ping Pong	Legacy	Line 6 Original
Dynamic	Legacy	TC Electronic® 2290
Stereo	Legacy	Line 6 Original
Digital	Legacy	Line 6 Original
Dig w/Mod	Legacy	Line 6 Original
Reverse	Legacy	Line 6 Original
Lo Res	Legacy	Line 6 Original
Tube Echo	Legacy	Maestro® Echoplex EP-1
Tape Echo	Legacy	Maestro® Echoplex EP-3
Sweep Echo	Legacy	Line 6 Original

*See “U.S. Registered Trademarks” on page 70. All product names used in this document are trademarks of their respective owners and neither Yamaha Guitar Group nor Line 6 are associated or affiliated with them. These trademarks appear solely to identify products whose tones and sounds were studied by Line 6 during sound model development.

Delay Models

Model	Subcategories	Based On*
Echo Platter	Legacy	Binson® EchoRec®
Analog Echo	Legacy	BOSS® DM-2
Analog w/Mod	Legacy	Electro-Harmonix® Deluxe Memory Man
Auto-Volume Echo	Legacy	Line 6 Original
Multi-Head	Legacy	Roland® RE-101 Space Echo

Reverb Models

Model	Subcategory	Based On*
Glitz	Mono, Stereo	Line 6 Original
Ganymede	Mono, Stereo	Line 6 Original
Searchlights	Mono, Stereo	Line 6 Original
Plateaux	Mono, Stereo	Line 6 Original
Double Tank	Mono, Stereo	Line 6 Original
Plate	Legacy	Line 6 Original
Room	Legacy	Line 6 Original
Chamber	Legacy	Line 6 Original
Hall	Legacy	Line 6 Original
Echo	Legacy	Line 6 Original
Tile	Legacy	Line 6 Original
Cave	Legacy	Line 6 Original
Ducking	Legacy	Line 6 Original
Octo	Legacy	Line 6 Original
'63 Spring	Legacy	Line 6 Original
Spring	Legacy	Line 6 Original
Particle Verb	Legacy	Line 6 Original

Pitch/Synth Models

Model	Subcategories	Based On*
Pitch Wham	Mono, Stereo	Digitech® Whammy®
Twin Harmony	Mono, Stereo	Eventide® H3000

Pitch/Synth Models

Model	Subcategories	Based On*
Simple Pitch	Mono, Stereo	Line 6 Original
Dual Pitch	Mono, Stereo	Line 6 Original
3 OSC Synth	Stereo	Line 6 Original
3 Note Generator	Mono, Stereo	Line 6 Original
4 OSC Generator	Mono, Stereo	Line 6 Original
Bass Octaver	Legacy	EBS® OctaBass
Smart Harmony	Legacy	Eventide® H3000
Octi Synth	Legacy	Line 6 Original
Synth O Matic	Legacy	Line 6 Original
Attack Synth	Legacy	Korg® X911 Guitar Synth
Synth String	Legacy	Roland® GR700 Guitar Synth
Growler	Legacy	Line 6 Original

Filter Models

Model	Subcategories	Based On*
Mutant Filter	Mono, Stereo	Musitronics® Mu-Tron® III
Mystery Filter	Mono, Stereo	Korg® A3
Autofilter	Mono, Stereo	Line 6 Original
Asheville Pattn	Mono, Stereo	Moog® Moogerfooger® MF-105M MuRF Filter
Voice Box	Legacy	Line 6 Original
V Tron	Legacy	Musitronics® Mu-Tron® III
Q Filter	Legacy	Line 6 Original
Seeker	Legacy	Z Vex Seek Wah
Obi Wah	Legacy	Oberheim® voltage-controlled S&H filter
Tron Up	Legacy	Musitronics® Mu-Tron® III (up position)
Tron Down	Legacy	Musitronics® Mu-Tron® III (down position)
Throbber	Legacy	Electrix® Filter Factory
Slow Filter	Legacy	Line 6 Original
Spin Cycle	Legacy	Craig Anderton's Wah/Anti-Wah
Comet Trails	Legacy	Line 6 Original

*See "U.S. Registered Trademarks" on page 70. All product names used in this document are trademarks of their respective owners and neither Yamaha Guitar Group nor Line 6 are associated or affiliated with them. These trademarks appear solely to identify products whose tones and sounds were studied by Line 6 during sound model development.

Wah Models

Model	Subcategories	Based On*
UK Wah 846	Mono, Stereo	Vox® V846
Teardrop 310	Mono, Stereo	Dunlop® Cry Baby® Fasel model 310
Fassel	Mono, Stereo	Dunlop® Cry Baby® Super
Weeper	Mono, Stereo	Arbiter® Cry Baby®
Chrome	Mono, Stereo	Vox® V847
Chrome Custom	Mono, Stereo	Modded Vox® V847
Throaty	Mono, Stereo	RMC® Real McCoy 1
Vetta Wah	Mono, Stereo	Line 6 Original
Colorful	Mono, Stereo	Colorsound® Wah-fuzz
Conductor	Mono, Stereo	Maestro® Boomerang

Volume/Pan Models

Model	Subcategories	Based On*
Volume Pedal	Mono, Stereo	Line 6 Original
Gain	Mono, Stereo	Line 6 Original
Pan	Stereo	Line 6 Original
Stereo Width	Stereo	Line 6 Original

Common FX Settings

Parameter	Description
Drive	Adjusts the amount of overdrive, distortion, or fuzz.
Bass	Adjusts the bass level.
Mid	Adjusts the midrange level.
Treble	Adjusts the treble level.
Speed	Adjusts the speed of the effect, with higher settings providing faster rates. Activate the model's Note Sync parameter to toggle between Hz and note values. Choosing a Hz value provides a specific modulation speed in cycles per second; choosing a note value provides a time based on the current tempo. Not all Speed parameters can be synced to note values, as they may be non-linear and highly interactive.
Rate	Adjusts the rate of the effect, with higher settings providing faster rates. Activate the model's Note Sync parameter to toggle between Hz and note values. Not all Rate parameters can be synced to note values, as they may be non-linear and highly interactive.

Parameter	Description
Time	Adjusts the delay/repeat time, with higher settings providing longer delays. Activate the model's Note Sync parameter to toggle between Hz and note values. Choosing a ms value provides a specific time in milliseconds; choosing a note division value provides a time based on the current tempo. With a note division value, this parameter's value is retained when changing models.
Depth	Adjusts the intensity of the modulation. Higher settings result in more extreme pitch bending, wobble, or throb, depending on the effect.
Feedback	Adjusts the amount of delayed signal fed back into the effect. Higher settings can provide more dramatic textures.
Decay	Sets the length of time the reverb effect sustains.
Predelay	Determines the time before the reverb effect is heard.
Scale	On stereo delays, the Scale offers control over the left & right channel repeats proportionately. The left channel repeats following the Time value and the right channel will repeat at a time that is the percentage of the left time. For example, if a delay's Time is set for 1 second and the Scale set to 75%, the left channel will repeat at 1 second and the right at 750 milliseconds (ms).
Spread	Spread differs slightly among stereo delay effects. For most delays, it adjusts how widely the repeats bounce left and right. With the Ping Pong Delay, for example, 0 is in the middle (mono), and 10 is full left to right panning for the repeats. For modulated stereo delays, Spread affects the LFOs' (low frequency oscillators) stereo modulation behavior. At 0 the LFOs are in sync. At 10, the two LFOs are 180 degrees out of sync, so that when one side is modulating up, the other side is modulating down.
Headroom	Some mod and delay pedals' internal signal paths exhibit a bit of grit, especially when placed after a high-gain amp block. Negative values increase the perceived amount of grit; positive values clean things up a bit. At 0dB, the model behaves like the original pedal.
Low Cut	Filters a portion of the block's bass and/or treble frequencies, which can help remove rumble and/or high-end harshness.
High Cut	
Mix	Blends the effected "wet" signal vs. the "dry" signal passed through the block. When set to 0%, the path bypasses the effect completely. When set to 100%, the entire path is fed through the effect, and no dry thru signal is heard.
Level	Adjusts the overall output level of the effects block. Be careful not to boost this parameter too high on multiple blocks, as digital clipping could occur. You should typically leave this at 0.0dB for most blocks. Where the original pedal's level or volume knob behavior doesn't really apply to dB values, 0.0-10 may be used.
Trails	<i>Trails Off:</i> Any delay repeats or reverb decays are instantly muted when the block is bypassed. <i>Trails On:</i> Any delay repeats or reverb decays continue to decay naturally when the block is bypassed or a different snapshot is selected.

*See "U.S. Registered Trademarks" on page 70. All product names used in this document are trademarks of their respective owners and neither Yamaha Guitar Group nor Line 6 are associated or affiliated with them. These trademarks appear solely to identify products whose tones and sounds were studied by Line 6 during sound model development.

Amp Models

The following guitar & bass amp models are found within the Helix Native Amp+Cab, Amp and Preamp block category menus. Note that you'll also see Guitar and Bass subcategories for the Amp+Cab & Amp categories, and Guitar, Bass and Mic subcategories for the Preamp category.

NOTE: Amp, Preamp, Cab, and Mic models are not supported when Helix Native is in the HX Effects Hardware Compatibility mode, therefore, you will not see these categories or models within the Helix Native menus when the HX Effects mode is in use—see [page 13](#).

- **Amp+Cab** blocks include an Amp plus a matched Cab model. You can change out the Cab for sonic variation (see the list of [“Speaker Cabinet Models” on page 68](#)).
- **Amp** blocks are identical to Amp+Cab blocks, except they contain no matched Cab model. Using an Amp block is the best choice if you want to use an IR block. Or try using a few IR or Cab blocks in a parallel Split Path for even more variation.
- **Preamp** versions of each amp model are also included, which provide the tone of just the preamp stage of the amp. Preamp blocks require less computer processing than a full Amp block.

Amp Models		
Model	Subcategory	Based On*
WhoWatt 100	Guitar	Hiwatt® DR-103 Brill
Soup Pro	Guitar	Supro® S6616
Stone Age 185	Guitar	Gibson® EH-185
Voltage Queen	Guitar	Victoria Vintage Queen
Tweed Blues Nrm	Guitar	Fender® Bassman® (normal channel)
Tweed Blues Brt	Guitar	Fender® Bassman® (bright channel)
Fullerton Nrm	Guitar	Fender® 5C3 Tweed Deluxe (normal channel)
Fullerton Brt	Guitar	Fender® 5C3 Tweed Deluxe (bright channel)
Fullerton Jump	Guitar	Fender® 5C3 Tweed Deluxe (jumped channels)
Grammatico Nrm	Guitar	Grammatico® LaGrange (normal channel)
Grammatico Brt	Guitar	Grammatico® LaGrange (bright channel)
Grammatico Jump	Guitar	Grammatico® LaGrange (jumped channels)
US Small Tweed	Guitar	Fender® Champ®
US Deluxe Nrm	Guitar	Fender® Deluxe Reverb® (normal channel)

Amp Models		
Model	Subcategory	Based On*
US Deluxe Vib	Guitar	Fender® Deluxe Reverb® (vibrato channel)
US Double Nrm	Guitar	Fender® Twin Reverb® (normal channel)
US Double Vib	Guitar	Fender® Twin Reverb® (vibrato channel)
Mail Order Twin	Guitar	Silvertone® 1484
Divided Duo	Guitar	÷13 JRT 9/15
Interstate Zed	Guitar	Dr Z® Route 66
Derailed Ingrid	Guitar	Trainwreck® Circuits Express
Jazz Rivet 120	Guitar	Roland® JC-120 Jazz Chorus
Essex A15	Guitar	Vox® AC-15
Essex A30	Guitar	Vox® AC-30 with top boost
A30 Fawn Nrm	Guitar	Vox® AC-30 Fawn (normal channel)
A30 Fawn Brt	Guitar	Vox® AC-30 Fawn (bright channel)
Matchstick Ch1	Guitar	Matchless® DC30 (channel 1)
Matchstick Ch2	Guitar	Matchless® DC30 (channel 2)
Matchstick Jump	Guitar	Matchless® DC30 (jumped)
Mandarin 80	Guitar	Orange® OR80
Brit J45 Nrm	Guitar	Marshall® JTM-45 (normal channel)
Brit J45 Brt	Guitar	Marshall® JTM-45 (bright channel)
Brit Trem Nrm	Guitar	Marshall® JTM-50 (normal channel)
Brit Trem Brt	Guitar	Marshall® JTM-50 (bright channel)
Brit Trem Jump	Guitar	Marshall® JTM-50 (jumped)
Brit Plexi Nrm	Guitar	Marshall® Super Lead 100 (normal channel)
Brit Plexi Brt	Guitar	Marshall® Super Lead 100 (bright channel)
Brit Plexi Jump	Guitar	Marshall® Super Lead 100 (jumped)
Brit P75 Nrm	Guitar	Park® 75 (normal channel)
Brit P75 Brt	Guitar	Park® 75 (bright channel)
Brit 2204	Guitar	Marshall® JCM-800
Placater Clean	Guitar	Friedman BE-100 (clean channel)
Placater Dirty	Guitar	Friedman BE-100 (BE/HBE channel)

*See [“U.S. Registered Trademarks” on page 70](#). All product names used in this document are trademarks of their respective owners and neither Yamaha Guitar Group nor Line 6 are associated or affiliated with them. These trademarks appear solely to identify products whose tones and sounds were studied by Line 6 during sound model development.

Amp Models		
Model	Subcategory	Based On*
Cartographer	Guitar	Ben Adrian Cartographer
German Mahadeva	Guitar	Bogner® Shiva
German Ubersonic	Guitar	Bogner® Überschall®
Cali Texas Ch1	Guitar	MESA/Boogie® Lone Star (clean channel)
Cali Texas Ch2	Guitar	MESA/Boogie® Lone Star (drive channel)
Cali IV Rhythm 1	Guitar	MESA/Boogie® Mark IV (channel I)
Cali IV Rhythm 2	Guitar	MESA/Boogie® Mark IV (channel II)
Cali IV Lead	Guitar	MESA/Boogie® Mark IV (lead channel)
Cali Rectifire	Guitar	MESA/Boogie® Dual Rectifier®
Archetype Clean	Guitar	Paul Reed Smith® Archon® (clean channel)
Archetype Lead	Guitar	Paul Reed Smith® Archon® (lead channel)
ANGL Meteor	Guitar	ENGL® Fireball 100
Solo Lead Clean	Guitar	Soldano SLO-100 (clean channel)
Solo Lead Crunch	Guitar	Soldano SLO-100 (crunch channel)
Solo Lead OD	Guitar	Soldano SLO-100 (overdrive channel)
PV Panama	Guitar	Peavey® 5150®
Revv Gen Purple	Guitar	Revv® Generator 120 (purple/gain ch. 3)
Revv Gen Red	Guitar	Revv® Generator 120 (red/high gain ch. 4)
Line 6 Elektrik	Guitar	Line 6 Original
Line 6 Doom	Guitar	Line 6 Original
Line 6 Epic	Guitar	Line 6 Original
Line 6 2204 Mod	Guitar	Line 6 Original
Line 6 Fatality	Guitar	Line 6 Original
Line 6 Litigator	Guitar	Line 6 Original
Line 6 Badonk	Guitar	Line 6 Original
Ampeg B-15NF	Bass	Ampeg® B-15NF Portaflex®
Ampeg SVT Nrm	Bass	Ampeg® SVT® (normal channel)
Ampeg SVT Brt	Bass	Ampeg® SVT® (bright channel)
Ampeg SVT-4 PRO	Bass	Ampeg® SVT®-4 PRO

Amp Models		
Model	Subcategory	Based On*
Woody Blue	Bass	Acoustic® 360
Agua 51	Bass	Aguilar® DB51
Cali Bass	Bass	MESA/Boogie® M9 Carbine
Cali 400 Ch1	Bass	MESA/Boogie® Bass 400+ (channel 1)
Cali 400 Ch2	Bass	MESA/Boogie® Bass 400+ (channel 2)
G Cougar 800	Bass	Gallien-Krueger® GK 800RB
Del Sol 300	Bass	Sunn® Coliseum 300
Busy One Ch1	Bass	Pearce BC-1 preamp (channel 1)
Busy One Ch2	Bass	Pearce BC-1 preamp (channel 2)
Busy One Jump	Bass	Pearce BC-1 preamp (jumped)
Studio Tube Pre	Preamp > Mic	Requisite Y7 mic preamp

Common Amp Settings

Parameter	Description
Master	Adjusts the amount of power amp distortion. This parameter is highly interactive with all other power amp parameters—the lower the Master is set, the less effect the other controls will have.
Sag	Lower Sag values offer a “tighter” responsiveness for metal and djent playing; higher values provide more touch dynamics & sustain for blues and classic rock riffs.
Hum Ripple	Controls how much heater hum and AC ripple interacts with your tone. At higher settings, things get freaky.
Bias	Changes the Bias of the power tubes. Lower values achieve a “colder” Class AB biasing. At maximum, the amp is operating in Class A.
Bias X	Determines how the power amp tubes' voicing reacts when pushed hard. Set low for a tighter feel. Set high for more tube compression. This parameter is highly reactive with the Drive and Master settings.

*See “U.S. Registered Trademarks” on page 70. All product names used in this document are trademarks of their respective owners and neither Yamaha Guitar Group nor Line 6 are associated or affiliated with them. These trademarks appear solely to identify products whose tones and sounds were studied by Line 6 during sound model development.

Speaker Cabinet Models

The following Cab models are available within the Amp+Cab and Cab block category menus. All Cab models also include your choice of Mic model type used on the Cab, as well as several Mic settings (see the list of [“Microphone Models” on page 69](#)).

There are two subcategories of Cab blocks—Single and Dual. Not surprisingly, Dual Cabs require twice as much processor usage as single Cabs. When you select a Dual Cab within the Model menu, you'll see two model tabs, allowing you to select the specific cab and settings for each. Dual Cab blocks are stereo, with each of the two cabs panned hard left and right.

NOTE: Amp, Preamp, Cab, and Mic models are not supported when Helix Native is in the HX Effects Hardware Compatibility mode, therefore, you will not see these categories or models within the Helix Native menus when the HX Effects mode is in use—see [page 13](#).

Cab Models		
Model	Subcategories	Based On*
Soup Pro Ellipse	Single, Dual	1 x 6x9" Supro® S6616
1x8 Small Tweed	Single, Dual	1x8" Fender® Champ
1x12 Field Coil	Single, Dual	1x12" Gibson® EH185
1x12 Fullerton	Single, Dual	1x12" Fender® 5C3 Tweed Deluxe
1x12 Grammatico	Single, Dual	1x12" Grammatico® LaGrange
1x12 US Deluxe	Single, Dual	1x12" Fender® Deluxe Oxford
1x12 Celest 12H	Single, Dual	1x12" ÷13 JRT 9/15 G12 H30
1x12 Blue Bell	Single, Dual	1x12" Vox® AC-15 Blue
1x12 Lead 80	Single, Dual	1x12" Bogner® Shiva CL80
1x12 Cali IV	Single, Dual	1x12" MESA/Boogie® Mk IV
1x12 Cali Ext	Single, Dual	1x12" MESA/Boogie® EVM12L
2x12 Double C12N	Single, Dual	2x12" Fender® Twin C12N
2x12 Mail C12Q	Single, Dual	2x12" Silvertone® 1484
2x12 Interstate	Single, Dual	2x12" Dr Z® Z Best V30
2x12 Jazz Rivet	Single, Dual	2x12" Roland® JC-120

Cab Models		
Model	Subcategories	Based On*
2x12 Silver Bell	Single, Dual	2x12" Vox® AC-30TB Silver
2x12 Blue Bell	Single, Dual	2x12" Vox® AC-30 Fawn Blue
2x12 Match H30	Single, Dual	1x12" Matchless® DC-30 G12H30
2x12 Match G25	Single, Dual	1x12" Matchless® DC-30 Greenback 25
4x10 Tweed P10R	Single, Dual	4x10" Fender® Bassman® P10R
4x12 WhoWatt 100	Single, Dual	4x12" Hiwatt® AP Fane®
4x12 Mandarin EM	Single, Dual	4x12" Orange® Eminence
4x12 Greenback25	Single, Dual	4x12" Marshall® Basketweave G12 M25
4x12 Greenback20	Single, Dual	4x12" Marshall® Basketweave G12 M20
4x12 Blackback30	Single, Dual	4x12" Park® 75 G12 H30
4x12 1960 T75	Single, Dual	4x12" Marshall® 1960 AT75
4x12 Uber V30	Single, Dual	4x12" Bogner® Uberkab V30
4x12 Uber T75	Single, Dual	4x12" Bogner® Uberkab T75
4x12 Cali V30	Single, Dual	4x12" MESA/Boogie® 4FB V30
4x12 XXL V30	Single, Dual	4x12" ENGL® XXL V30
4x12 SoloLead EM	Single, Dual	4x12" Soldano
1x12 Del Sol	Single, Dual	1x12" Sunn® Coliseum
1x15 Ampeg B-15	Single, Dual	1x15" Ampeg® B-15
1x18 Del Sol	Single, Dual	1x18" Sunn® Coliseum
1x18 Woody Blue	Single, Dual	1x18" Acoustic® 360
2x15 Brute	Single, Dual	2x15" MESA/Boogie® 2x15 EV
4x10 Ampeg HLF	Single, Dual	4x10" Ampeg® SVT® 410HLF
6x10 Cali Power	Single, Dual	6x10" MESA/Boogie® Power House
8x10 Ampeg SVT E	Single, Dual	8x10" Ampeg® SVT®

*See [“U.S. Registered Trademarks” on page 70](#). All product names used in this document are trademarks of their respective owners and neither Yamaha Guitar Group nor Line 6 are associated or affiliated with them. These trademarks appear solely to identify products whose tones and sounds were studied by Line 6 during sound model development.

Microphone Models

Mic Models	
Model	Based On*
57 Dynamic	Shure® SM57
409 Dynamic	Sennheiser® MD 409
421 Dynamic	Sennheiser® MD 421-U
30 Dynamic	Heil Sound® PR 30
20 Dynamic	Electro-Voice® RE20
121 Ribbon	Royer® R-121
160 Ribbon	Beyerdynamic® M 160
4038 Ribbon	Coles 4038
414 Cond	AKG® C414 TLII
84 Cond	Neumann® KM84
67 Cond	Neumann® U67
87 Cond	Neumann® U87
47 Cond	Neumann® U47
112 Dynamic	AKG® D112
12 Dynamic	AKG® D12
7 Dynamic	Shure® SM7

Cab & Mic Settings

Knob	Parameter	Description
1	Mic	Selects one of the 16 available mic models.
2	Distance	Sets the distance (1 inch to 12 inches) between the mic and the speaker grille.
3	Low Cut	Filters a portion of the cab's bass and/or treble frequencies, which can help remove rumble and/or high-end harshness.
4	High Cut	
5	EarlyReflec	Sets the amount of "early reflections." Higher values add more reflective room sound to your Amp tone.
6	Level	Adjusts the overall output level of the Cab.

*See "U.S. Registered Trademarks" on page 70. All product names used in this document are trademarks of their respective owners and neither Yamaha Guitar Group nor Line 6 are associated or affiliated with them. These trademarks appear solely to identify products whose tones and sounds were studied by Line 6 during sound model development.

U.S. Registered Trademarks

All product names used in this document are trademarks of their respective owners and neither Yamaha Guitar Group nor Line 6 are associated or affiliated with them. These trademarks appear solely to identify products whose tones and sounds were studied by Line 6 during sound model development.

5150 is a registered trademark of ELVH Inc.

Acoustic is a registered trademark of GTRC Services, Inc.

Aguilar is a registered trademark David Boonshoft.

AKG, DOD and Whammy are registered trademarks of Harman International Industries, Inc.

Arbiter is a registered trademark of Sound City Amplification LLC.

Binson, Dytronic, LA-2A and Teletronix are registered trademarks of Universal Audio, Inc.

Beyerdynamic is a registered trademark of Beyer Dynamic GmbH & Co. KG.

Bogner and Überschall are registered trademarks of Bogner Amplification.

BOSS and Roland are registered trademarks of Roland Corporation U.S.

Carvin is a registered trademark of Kiesel Guitars.

Colorsound is a registered trademark of Sola Sound Limited Corporation, UK.

Cry Baby, Dunlop, Fuzz Face, MXR, and Uni-Vibe, are registered trademarks of Dunlop Manufacturing, Inc.

Darkglass and Microtubes are registered trademarks of Darkglass Electronics, TMI Douglas Castro.

Digitech is a registered trademark of DOD Electronics Corporation.

Dr. Z is a registered trademark of Dr. Z Amps, Inc.

EBS is a registered trademark according of EBS Holding.

EchoRec is a registered trademark of Nicholas Harris.

Electro-Harmonix and Big Muff Pi are registered trademarks of New Sensor Corp.

Electro-Voice is a registered trademark of Bosch Security Systems, Inc.

Engl is a registered trademark of Beate Ausflug and Edmund Engl.

Eventide is a registered trademark of Eventide Inc.

Fane is a trademark of Fane International Ltd.

Fender, Twin Reverb, Bassman, Champ, Deluxe Reverb and Sunn are registered trademarks of Fender Musical Instruments Corp.

Fulltone is a registered trademark of Fulltone Musical Products, Inc.

Gallien-Krueger is a registered trademark of Gallien Technology, Inc.

Gibson and Maestro are registered trademarks of Gibson Guitar Corp.

Heil Sound is a registered trademark of Heil Sound Ltd.

Hiwatt is a registered trademark of Simon Giles and Justin Harrison.

Ibanez is a registered trademark of Hoshino, Inc.

Klon is a registered trademark of Klon, LLC.

Korg is a registered trademark of Korg, Inc.

Leslie is a registered trademark of Suzuki Musical Instrument Manufacturing Co. Ltd.

Lone Star is a registered trademark of Randall C. Smith.

Marshall is a registered trademark of Marshall Amplification Plc.

Matchless is a registered trademark of Matchless, LLC.

MAXON is a registered trademark of Nisshin Onpa Co., Ltd.

Mesa/Boogie and Rectifier are registered trademarks of Mesa/Boogie, Ltd.

Moog and Moogerfooger are registered trademarks of Moog Music, Inc.

Musitronics is a registered trademark of Mark S. Simonsen.

Mu-Tron is a registered trademark of Henry Zajac.

Neumann is a registered trademark of Georg Neumann GmbH.

Orange is a registered trademark of Orange Brand Services Limited.

Park is a registered trademark of AMP RX LLC.

Paul Reed Smith and Archon are registered trademarks of Paul Reed Smith Guitars, LP.

Peavey is a registered trademark of Peavey Electronics Corporation.

Revv is a registered trademark of Revv Amplification Inc.

RMC is a registered trademark of Richard McClish.

Royer is a registered trademark of Bulldog Audio, Inc. DBA Rover Labs.

Sennheiser is a registered trademark of Sennheiser Electronic GmbH & Co. KG.

Shure is a registered trademark of Shure Inc.

Silvertone is a registered trademark of Samick Music Corporation.

Supro is a registered trademark of Absara Audio LLC.

TC Electronic is a registered trademark of MUSIC Group IP Ltd.

Tech21 is a registered trademark of Tech21 Licensing Ltd.

Timmy is a registered trademark of Paul Cochrane AKA PAULCAUDIO.

Trainwreck is a registered trademark of of Scott Alan Fischer and Mona Fischer.

Tube Screamer is a registered trademark of Hoshino Gakki Co. Ltd.

Tycobrahe is a registered trademark of Kurt Stier.

Vox is a registered trademark of Vox R&D Limited.

Way Huge is a registered trademark of Saucy Inc.

Xotic is a registered trademark of Prosound Communications, Inc.

*See [“U.S. Registered Trademarks” on page 70](#). All product names used in this document are trademarks of their respective owners and neither Yamaha Guitar Group nor Line 6 are associated or affiliated with them. These trademarks appear solely to identify products whose tones and sounds were studied by Line 6 during sound model development.

Additional Resources

Looking for more info? We've got plenty of online resources, just a click away.

- Download additional Help documentation covering Helix family devices and software from the Line 6 website at [Line 6 Product Manuals](#)
- Check out the [Line 6 Support](#) page for access to helpful tips, videos, discussion forums, or to contact Line 6 Technical Support
- Stay up to date with the latest updated version of Helix Native and all your other Line 6 applications, available from the [Line 6 Software Downloads](#) page
- Looking for some professionally crafted presets and Impulse Responses for your Helix device or Helix Native plug-in? Check out the new [Marketplace](#), and be sure to check back often for news and product announcements
- Visit the [Line 6 CustomTone](#) site where you can share your Helix presets with the world, and download free presets created by Line 6 and other users just like you
- Can't get enough Line 6 Gear & accessories? Head on over to the [Line 6 Store](#)

